

Material ABS; Polycarbonat
 Farbton ähnlich RAL 7035
 Dichtung Chloropren (Silikon auf Anfrage)
 Einsatztemperatur -40°C bis +100°C
 Schutzart IP66

Material ABS; Polycarbonate
 Colour similar to RAL 7035
 Sealing Chloroprene (Silicone on Request)
 Operating Temperature -40°C to +100°C
 Protection Class IP66

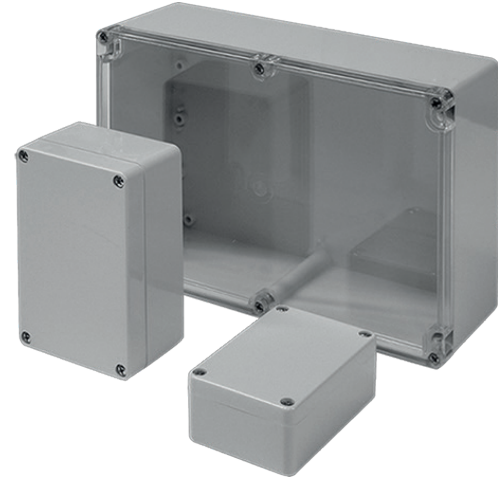

Gehäuse
 Enclosure
 STANDARDGEHÄUSE
 ABS + PC + PC with
 clear lid
 52 x 50 x 35 mm

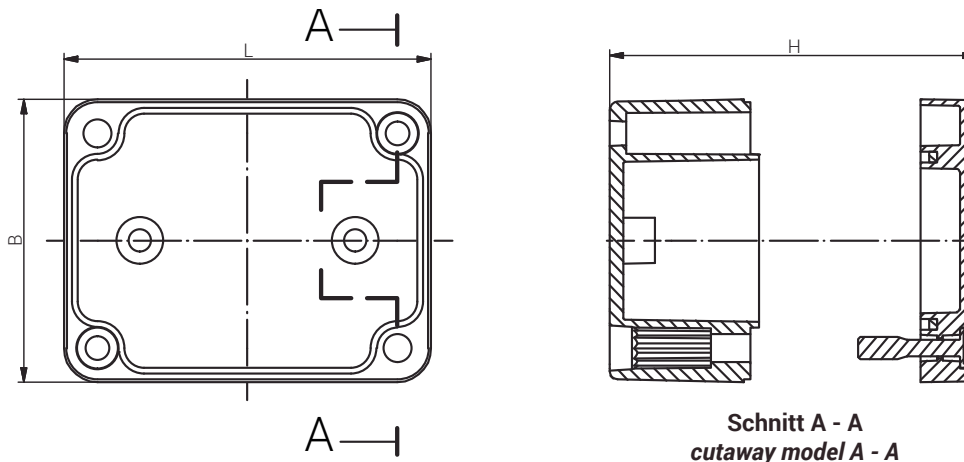

Produktdokumentation
 Product Documentation



 Artikel Article		Artikel Article		Artikel Article	
ABS	Gewicht / Weight kg	Polycarbonate	Gewicht / Weight kg	Polycarbonate with clear lid	Gewicht / Weight kg
01 050504 000	0,038	02 050504 000	0,039	02 050504 045	0,044

RST Rabe-System-Technik und Vertriebs-GmbH
 Otto-Lilienthal-Strasse 19
 49134 Wallenhorst

DEUTSCHLAND

+49 5407 8766-0
 +49 5407 8766-99
 info@rst.eu
 www.rst.eu

Material	ABS; Polycarbonat
Farbton	ähnlich RAL 7035
Dichtung	Chloropren (Silikon auf Anfrage)
Einsatztemperatur	-40°C bis +100°C
Schutzart	IP66

Material	ABS; Polycarbonate
Colour	similar to RAL 7035
Sealing	Chloroprene (Silicone on Request)
Operating Temperature	-40°C to +100°C
Protection Class	IP66

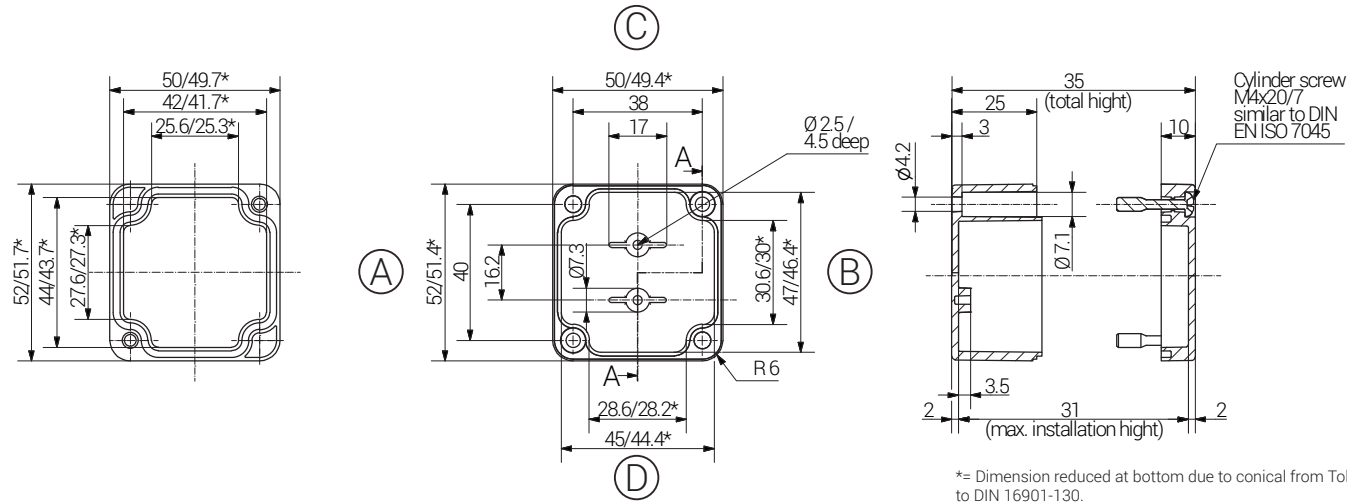

Gehäuse
Enclosure
STANDARDGEHÄUSE
ABS + PC + PC with
clear lid

Produktdokumentation
Product Documentation



Article			Length (mm)	Width (mm)	Height (mm)	DIN Rail for Terminals			Mounting Plate Thickness (in mm)	External Mounting Brackets (set)	External Hinge Appr. 150°C (PC pair)
ABS	Polycarbonate	Polycarbonate with clear lid				TS15	TS32	TS35			
01 050504 000	02 050504 000	02 050504 045	52	50	35	X	-	-	1,5	-	-

Max. Bestückungsmöglichkeit für Kabelverschraubungen
Max. assembly with cable glands

M	Eckmaß across corner	Seite / Side				PG	Eckmaß across corner	Seite / Side			
		A	B	C	D			A	B	C	D
12	17,25	2		1		7	17,25	2		1	
16	25,30					9	21,85	1		1	
20	27,60					11	25,30				
25	37,95					13,5	27,60				
32	48,30					16	31,05				
40	60,95					21	37,95				
50	69,00					29	48,30				
63	74,75					36	60,95				
						42	69,00				
						48	74,75				

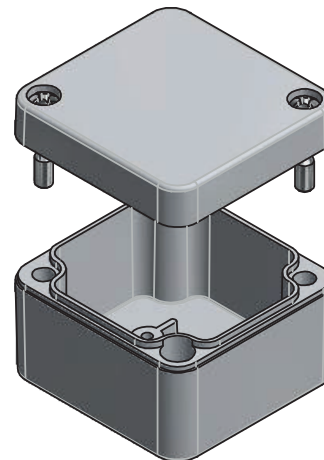

RST Rabe-System-Technik und Vertriebs-GmbH
Otto-Lilienthal-Strasse 19
49134 Wallenhorst

DEUTSCHLAND

+49 5407 8766-0
+49 5407 8766-99
info@rst.eu
www.rst.eu