

Material Edelstahl
 Dichtung Silikon

Einsatztemperatur -55°C bis +135°C
 Schutzart IP66

Material Stainless Steel
 Sealing Silicone

Operating Temperature -55°C to +135°C
 Protection Class IP66

Für besondere Bedingungen oder Einschränkungen siehe entsprechende Produktdokumentation.

For specific conditions or limitations please see relevant product documentation.



Gehäuse
 Enclosure
 EX-GEHÄUSE 1.4404
 Ex e & Ex ia
 300 x 200 x 121 mm

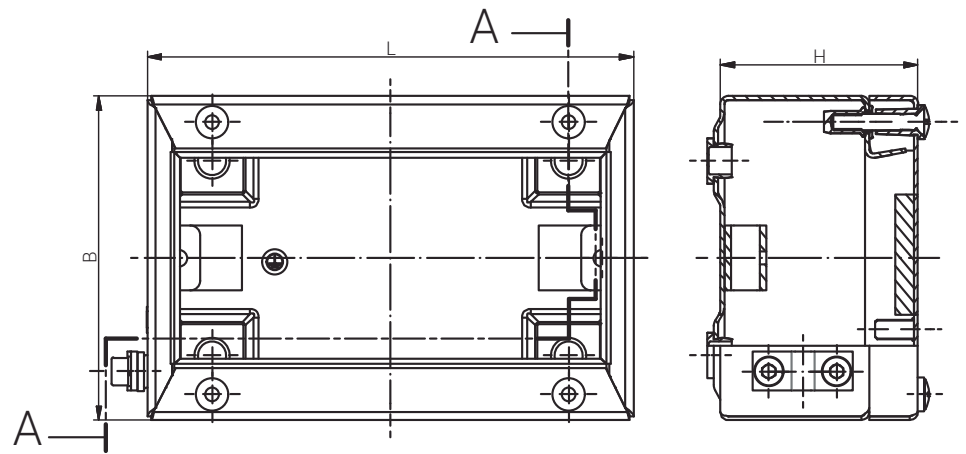

Schnitt A - A
 cutaway model A - A

Produktdokumentation
 Product Documentation



RST Rabe-System-Technik und Vertriebs-GmbH
 Otto-Lilienthal-Strasse 19
 49134 Wallenhorst
 DEUTSCHLAND
 +49 5407 8766-0
 +49 5407 8766-99
 info@rst.eu
 www.rst.eu

	Artikel Article	Artikel Article		
Edelstahl 1.4404 Ex e	Gewicht / Weight kg	Edelstahl 1.4404 Ex ia	Gewicht / Weight kg	
21 302012 000	2,790	22 302012 000	2,790	

Material	Edelstahl
Dichtung	Silikon
Einsatztemperatur	-55°C bis +135°C
Schutzart	IP66

Material	Stainless Steel
Sealing	Silicone
Operating Temperature	-55°C to +135°C
Protection Class	IP66

Für besondere Bedingungen oder Einschränkungen siehe entsprechende Produktdokumentation.

For specific conditions or limitations please see relevant product documentation.

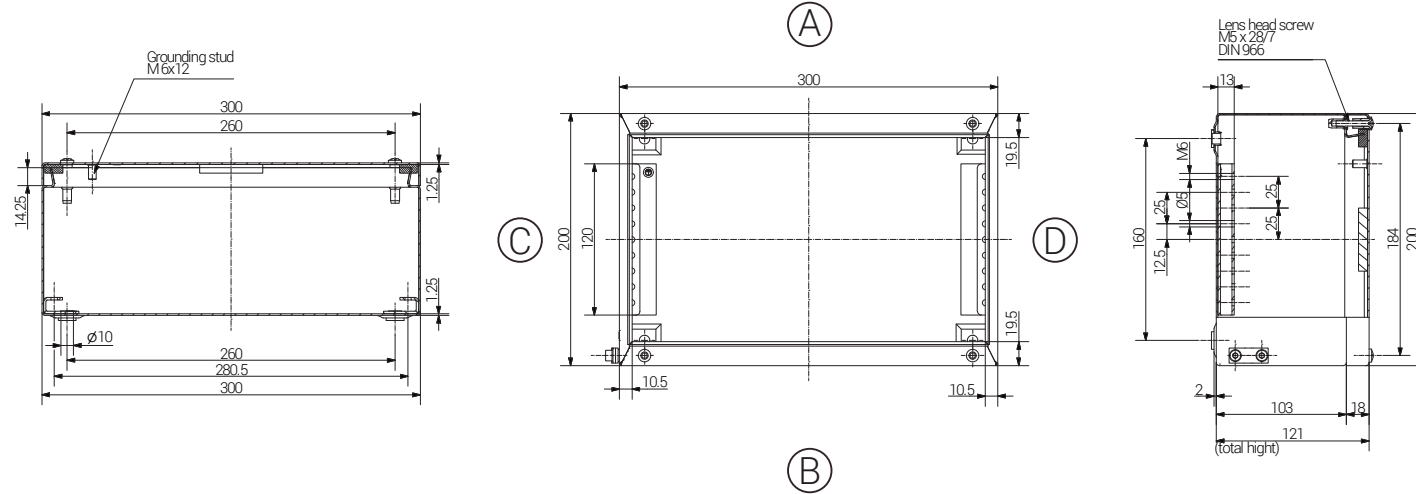

Gehäuse
Enclosure
EX-GEHÄUSE 1.4404
Ex e & Ex ia

Produktdokumentation
Product Documentation



RST Rabe-System-Technik und Vertriebs-GmbH
Otto-Lilienthal-Strasse 19
49134 Wallenhorst

DEUTSCHLAND

+49 5407 8766-0
+49 5407 8766-99
info@rst.eu
www.rst.eu

www	Article		Length (mm)	Width (mm)	Height (mm)	DIN Rail for Terminals		PE busbar	Mounting Plate Thickness in mm	External Mounting Brackets
	Edelstahl 1.4404 Ex e	Edelstahl 1.4404 Ex ia				TS15	TS35			
21 302012 000	22 302012 000	300	200	121	-	X	1	2,0	X	

Max. Bestückungsmöglichkeit für Kabelverschraubungen
Max. assembly with cable glands

M	Eckmaß across corner	Seite / Side				PG	Eckmaß across corner	Seite / Side			
		A	B	C	D			A	B	C	D
12	17,25	84	45	7	17,25	84	45				
16	25,30	38	20	9	21,85	48	28				
20	27,60	28	18	11	25,30	38	20				
25	37,95	14	8	13,5	27,60	28	18				
32	48,30	9	4	16	31,05	24	12				
40	60,95	4	2	21	37,95	14	8				
50	69,00	3	2	29	48,30	9	4				
63	74,75	3	2	36	60,95	4	2				
				42	69,00	3	2				
				48	74,75						

