

Material Edelstahl
 Dichtung Silikon

Einsatztemperatur -55°C bis +135°C
 Schutzart IP66

Material Stainless Steel
 Sealing Silicone

Operating Temperature -55°C to +135°C
 Protection Class IP66

Für besondere Bedingungen oder Einschränkungen siehe entsprechende Produktdokumentation.

For specific conditions or limitations please see relevant product documentation.



Gehäuse
 Enclosure
 EX-GEHÄUSE 1.4404
 Ex e & Ex ia
 300 x 300 x 121 mm

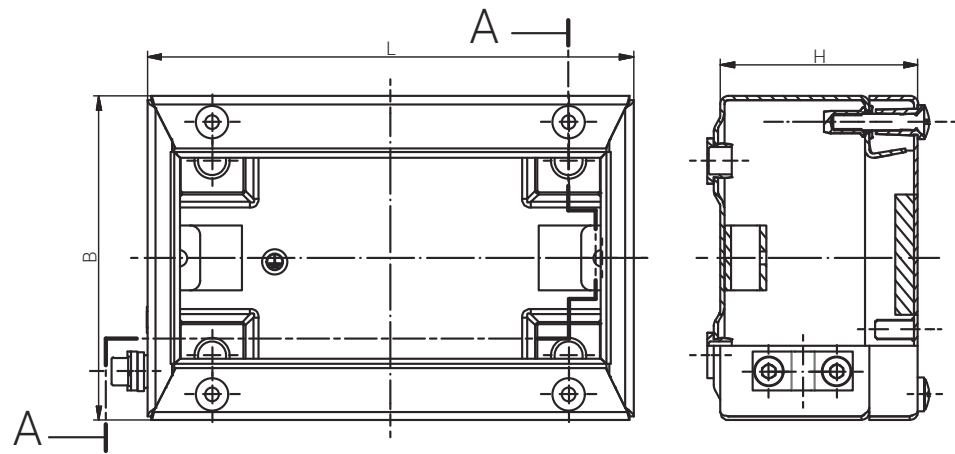

Schnitt A - A
 cutaway model A - A

Produktdokumentation
 Product Documentation



RST Rabe-System-Technik und Vertriebs-GmbH
 Otto-Lilienthal-Strasse 19
 49134 Wallenhorst
 DEUTSCHLAND
 +49 5407 8766-0
 +49 5407 8766-99
 info@rst.eu
 www.rst.eu

	Artikel Article	Artikel Article		
Edelstahl 1.4404 Ex e	Gewicht / Weight kg	Edelstahl 1.4404 Ex ia	Gewicht / Weight kg	
21 303012 000	3,812	22 303012 000	3,812	

Material	Edelstahl
Dichtung	Silikon
Einsatztemperatur	-55°C bis +135°C
Schutzart	IP66

Material	Stainless Steel
Sealing	Silicone
Operating Temperature	-55°C to +135°C
Protection Class	IP66

Für besondere Bedingungen oder Einschränkungen siehe entsprechende Produktdokumentation.

For specific conditions or limitations please see relevant product documentation.

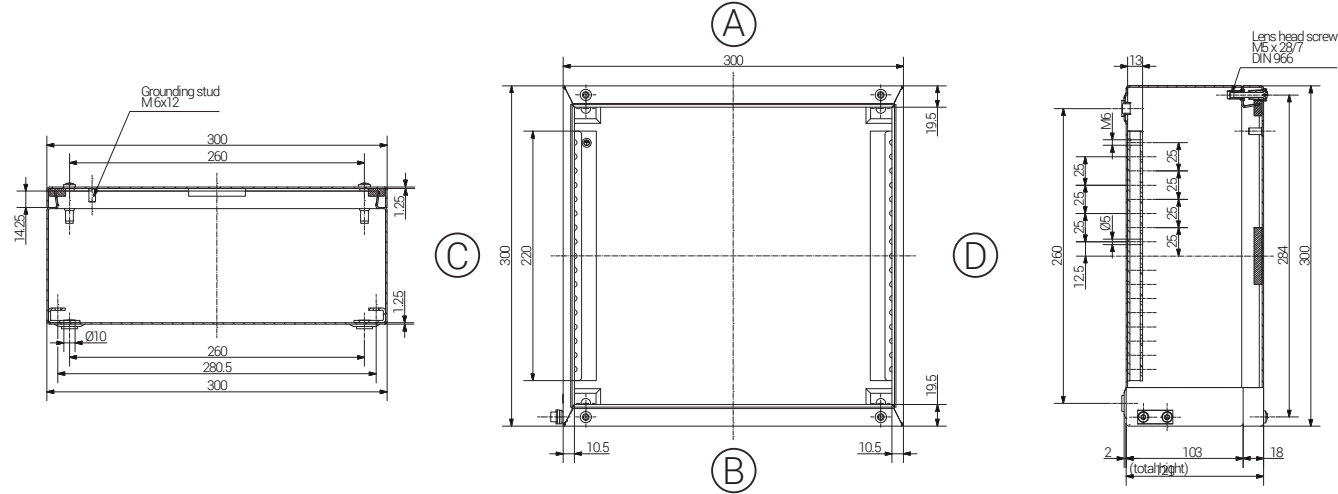

Gehäuse
Enclosure
EX-GEHÄUSE 1.4404
Ex e & Ex ia

Produktdokumentation
Product Documentation



RST Rabe-System-Technik und Vertriebs-GmbH
Otto-Lilienthal-Strasse 19
49134 Wallenhorst

DEUTSCHLAND

+49 5407 8766-0
+49 5407 8766-99
info@rst.eu
www.rst.eu

www	Article		Length (mm)	Width (mm)	Height (mm)	DIN Rail for Terminals		PE busbar	Mounting Plate Thickness in mm	External Mounting Brackets
	Edelstahl 1.4404 Ex e	Edelstahl 1.4404 Ex ia				TS15	TS35			
21 303012 000	22 303012 000	300	300	121	-	X	1	2,0	X	

Max. Bestückungsmöglichkeit für Kabelverschraubungen
Max. assembly with cable glands

M	Eckmaß across corner	Seite / Side				PG	Eckmaß across corner	Seite / Side			
		A	B	C	D			A	B	C	D
12	17,25	84	75	7	17,25	84	75				
16	25,30	38	32	9	21,85	48	46				
20	27,60	28	27	11	25,30	38	32				
25	37,95	14	14	13,5	27,60	28	27				
32	48,30	9	7	16	31,05	24	24				
40	60,95	4	4	21	37,95	14	14				
50	69,00	3	3	29	48,30	9	7				
63	74,75	3	3	36	60,95	4	4				
				42	69,00	3	3				
				48	74,75						

