

Material ABS; Polycarbonat
 Farbton ähnlich RAL 7035
 Dichtung Chloropren (Silikon auf Anfrage)
 Einsatztemperatur -40°C bis +100°C
 Schutzart IP66

Material ABS; Polycarbonate
 Colour similar to RAL 7035
 Sealing Chloroprene (Silicone on Request)
 Operating Temperature -40°C to +100°C
 Protection Class IP66

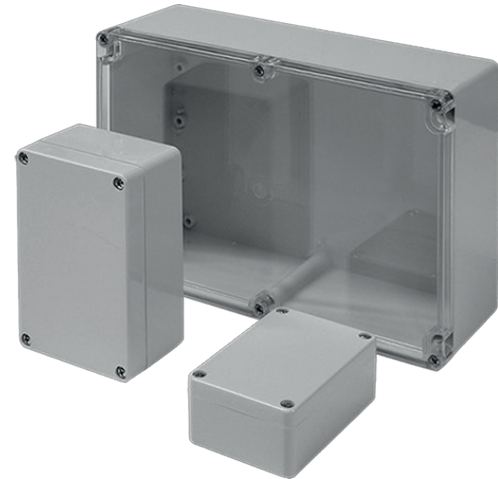

Gehäuse
 Enclosure
 STANDARDGEHÄUSE
 ABS + PC + PC with
 clear lid
 200 x 120 x 75 mm

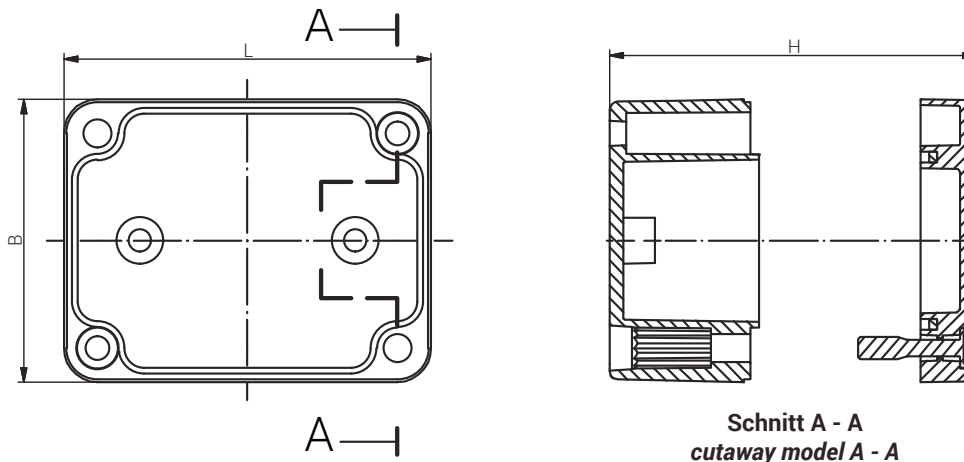

Produktdokumentation
 Product Documentation



 Artikel Article		Artikel Article		Artikel Article	
ABS	Gewicht / Weight kg	Polycarbonate	Gewicht / Weight kg	Polycarbonate with clear lid	Gewicht / Weight kg
01 201208 000	0,340	02 201208 000	0,340	02 201208 045	0,339

RST Rabe-System-Technik und Vertriebs-GmbH
 Otto-Lilienthal-Strasse 19
 49134 Wallenhorst

DEUTSCHLAND

+49 5407 8766-0
 +49 5407 8766-99
 info@rst.eu
 www.rst.eu

Material ABS; Polycarbonat
 Farbton ähnlich RAL 7035
 Dichtung Chloropren (Silikon auf Anfrage)
 Einsatztemperatur -40°C bis +100°C
 Schutzart IP66

Material ABS; Polycarbonate
 Colour similar to RAL 7035
 Sealing Chloroprene (Silicone on Request)
 Operating Temperature -40°C to +100°C
 Protection Class IP66

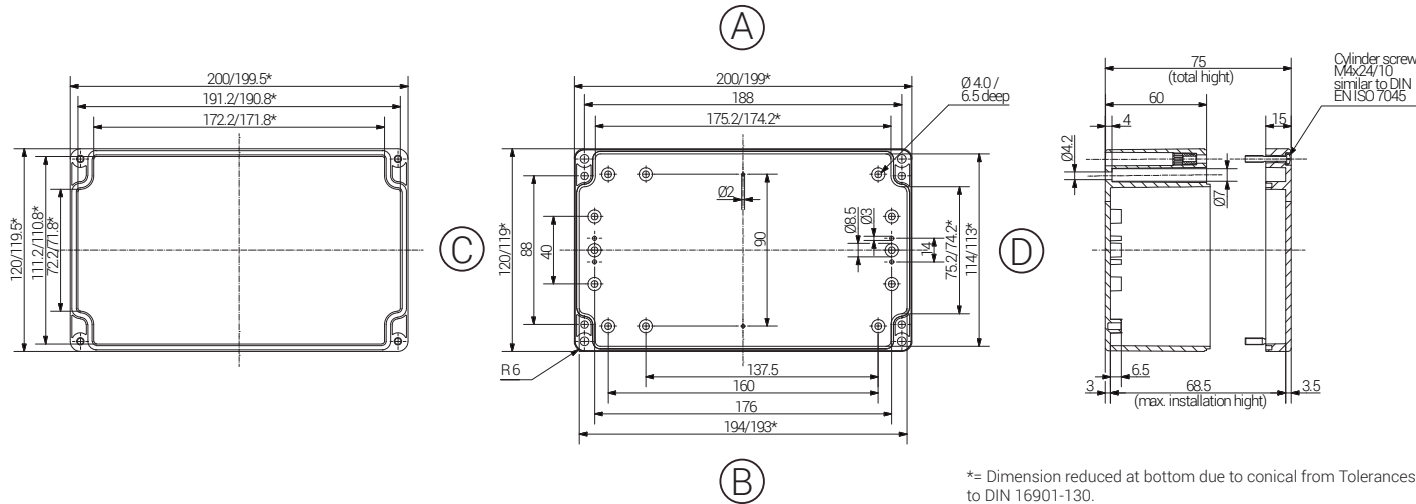

Gehäuse
 Enclosure
 STANDARDGEHÄUSE
 ABS + PC + PC with
 clear lid

Produktdokumentation
 Product Documentation



Article			Length (mm)	Width (mm)	Height (mm)	DIN Rail for Terminals			Mounting Plate Thickness in mm	External Mounting Brackets set	External Hinge Appr. 150°C PC pair
ABS	Polycarbonate	Polycarbonate with clear lid				TS15	TS32	TS35			
01 201208 000	02 201208 000	02 201208 045	200	120	75	X	X	X	2,0	X	X

Max. Bestückungsmöglichkeit für Kabelverschraubungen
 Max. assembly with cable glands

M	Eckmaß across corner	Seite / Side				PG	Eckmaß across corner	Seite / Side			
		A	B	C	D			A	B	C	D
12	17,25	30	15	7	17,25	30	15				
16	25,30	14	6	9	21,85	20	9				
20	27,60	12	6	11	25,30	12	6				
25	37,95	5	3	13,5	27,60	12	6				
32	48,30	3	2	16	31,05	10	4				
40	60,95			21	37,95	5	2				
50	69,00			29	48,30	3	2				
63	74,75			36	60,95						
				42	69,00						
				48	74,75						

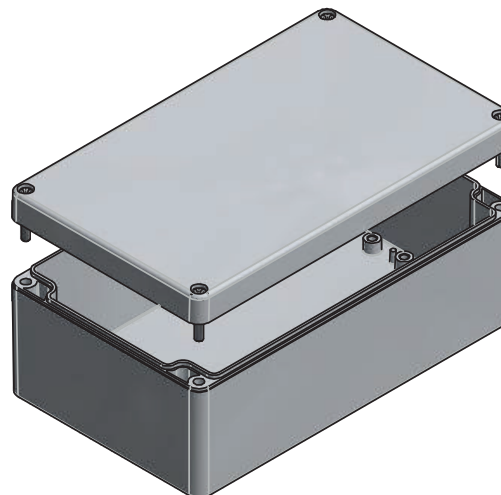

RST Rabe-System-Technik und Vertriebs-GmbH
 Otto-Lilienthal-Strasse 19
 49134 Wallenhorst

DEUTSCHLAND

+49 5407 8766-0
 +49 5407 8766-99
 info@rst.eu
 www.rst.eu