

Material	Polyester mit Graphitzusatz
Farbton	RAL 9011, schwarz
Dichtung	Silikon
Einsatztemperatur	-20°C bis +40°C - entspricht T6= +85°C Oberflächentemperatur (weitere auf Anfrage)
Schutzart	IP66

Material	Polyester, Graphite Added
Colour	RAL 9011, black
Sealing	Silicone
Operating Temperature	-20°C to +40°C - equal to T6 = +85°C surface temperature (Further on Request)
Protection Class	IP66

Für besondere Bedingungen oder Einschränkungen siehe entsprechende Produktdokumentation.

For specific conditions or limitations please see relevant product documentation.



Gehäuse
 Enclosure
 EX-GEHÄUSE PES
 Ex e & Ex ia
 600 x 250 x 120 mm

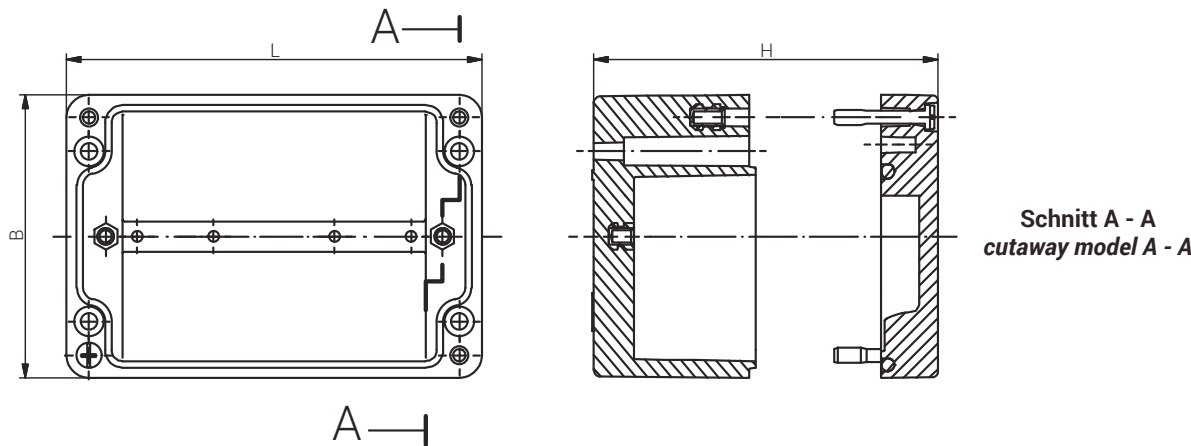

Produktdokumentation
 Product Documentation



RST Rabe-System-Technik und Vertriebs-GmbH
 Otto-Lilienthal-Strasse 19
 49134 Wallenhorst
 DEUTSCHLAND
 ☎ +49 5407 8766-0
 📠 +49 5407 8766-99
 ✉ info@rst.eu
 🌐 www.rst.eu

	Artikel Article	Artikel Article		
Polyester Ex e	Gewicht / Weight kg	Polyester Ex ia	Gewicht / Weight kg	
17 602512 000	5,520	18 602512 000	5,520	

Material Polyester mit Graphitzusatz
 Farbton RAL 9011, schwarz
 Dichtung Silikon
 Einsatztemperatur -20°C bis +40°C - entspricht T6= +85°C Oberflächentemperatur (weitere auf Anfrage)
 Schutzart IP66

Material Polyester, Graphite Added
 Colour RAL 9011, black
 Sealing Silicone
 Operating Temperature -20°C to +40°C - equal to T6 = +85°C surface temperature (Further on Request)
 Protection Class IP66

Für besondere Bedingungen oder Einschränkungen siehe entsprechende Produktdokumentation.

For specific conditions or limitations please see relevant product documentation.

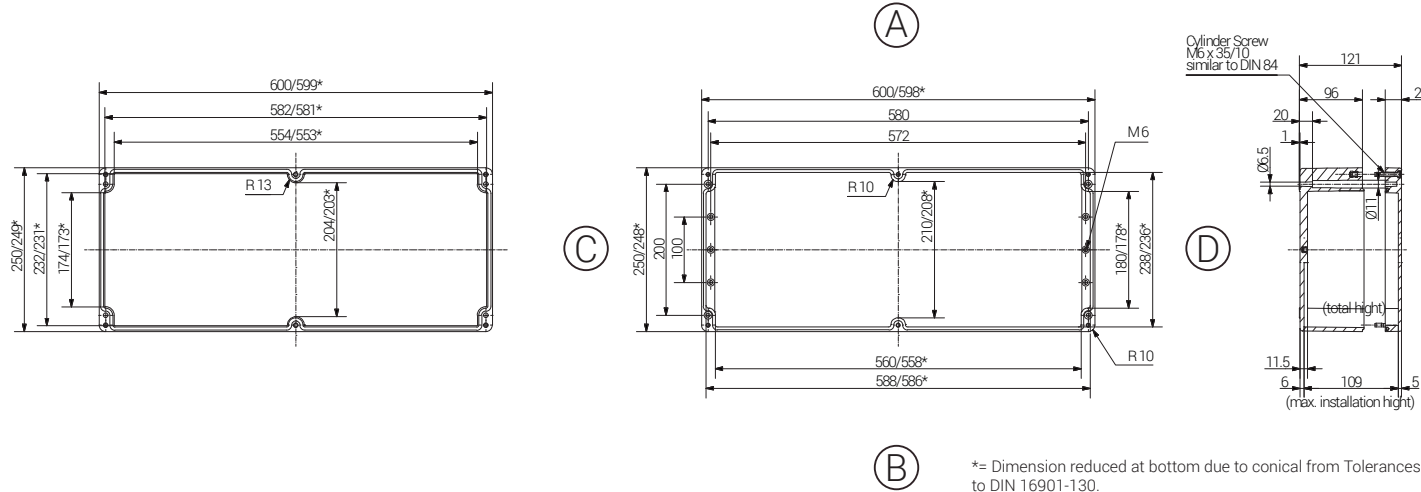

*= Dimension reduced at bottom due to conical from Tolerances to DIN 16901-130.

Gehäuse
 Enclosure
 EX-GEHÄUSE PES
 Ex e & Ex ia

Produktdokumentation
 Product Documentation



RST Rabe-System-Technik und Vertriebs-GmbH
 Otto-Lilienthal-Strasse 19
 49134 Wallenhorst

DEUTSCHLAND

+49 5407 8766-0
 +49 5407 8766-99
 info@rst.eu
 www.rst.eu

www	Article		Length (mm)	Width (mm)	Height (mm)	DIN Rail for Terminals		PE busbar	PE Anlege Brackets	Mounting Plate Thickness in mm	External Mounting Brackets Set	External Hinge Pair	Off-Shore Plate
	Polyester Ex e	Polyester Ex ia				TS15	TS35						
17 602512 000	18 602512 000	600	250	120	-	X	2	-	2,0 a)	X	X	X	

a) Sheet steel, zinc-plated

Max. Bestückungsmöglichkeit für Kabelverschraubungen
 Max. assembly with cable glands

M	Eckmaß across corner	Seite / Side				PG	Eckmaß across corner	Seite / Side			
		A	B	C	D			A	B	C	D
12	17,25	108	50	7	17,25	108	50				
16	25,30	52	24	9	21,85	64	32				
20	27,60	36	18	11	25,30	48	22				
25	37,95	30	10	13,5	27,60	36	18				
32	48,30	12	7	16	31,05	30	17				
40	60,95	6	3	21	37,95	18	9				
50	69,00	4	3	29	48,30	12	6				
63	74,75	4	2	36	60,95	6	3				
				42	69,00	4	2				
				48	74,75	4	2				

