

Material	Aluminium
Farbton	RAL 7001
Dichtung	Silikon
Einsatztemperatur	-20°C bis +40°C - entspricht T6= +85°C Oberflächentemperatur (weitere auf Anfrage)
Schutzart	IP66

Material	Aluminium
Colour	RAL 7001
Sealing	Silicone
Operating Temperature	-20°C to +40°C - equal to T6 = +85°C surface temperature (Further on Request)
Protection Class	IP66

Für besondere Bedingungen oder Einschränkungen siehe entsprechende Produktdokumentation.

For specific conditions or limitations please see relevant product documentation.



Gehäuse
Enclosure
EX-GEHÄUSE AL
Ex e & Ex ia
400 x 310 x 140 mm

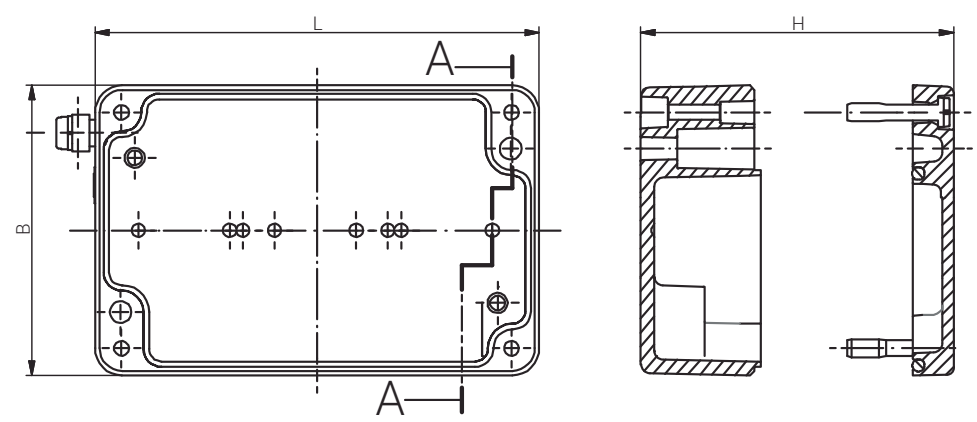

Schnitt A - A
cutaway model A - A

Produktdokumentation
Product Documentation



RST Rabe-System-Technik und Vertriebs-GmbH
Otto-Lilienthal-Strasse 19
49134 Wallenhorst
DEUTSCHLAND
☎ +49 5407 8766-0
☎ +49 5407 8766-99
✉ info@rst.eu
🌐 www.rst.eu

	Artikel Article	Artikel Article		
Aluminium Ex e	Gewicht / Weight kg	Aluminium Ex ia	Gewicht / Weight kg	
15 403114 000	7,000	16 403114 000	7,000	

Material Aluminium
 Farbton RAL 7001
 Dichtung Silikon
 Einsatztemperatur -20°C bis +40°C - entspricht T6= +85°C Oberflächentemperatur (weitere auf Anfrage)
 Schutzart IP66

Material Aluminium
 Colour RAL 7001
 Sealing Silicone
 Operating Temperature -20°C to +40°C - equal to T6 = +85°C surface temperature (Further on Request)
 Protection Class IP66

Für besondere Bedingungen oder Einschränkungen siehe entsprechende Produktdokumentation.

For specific conditions or limitations please see relevant product documentation.

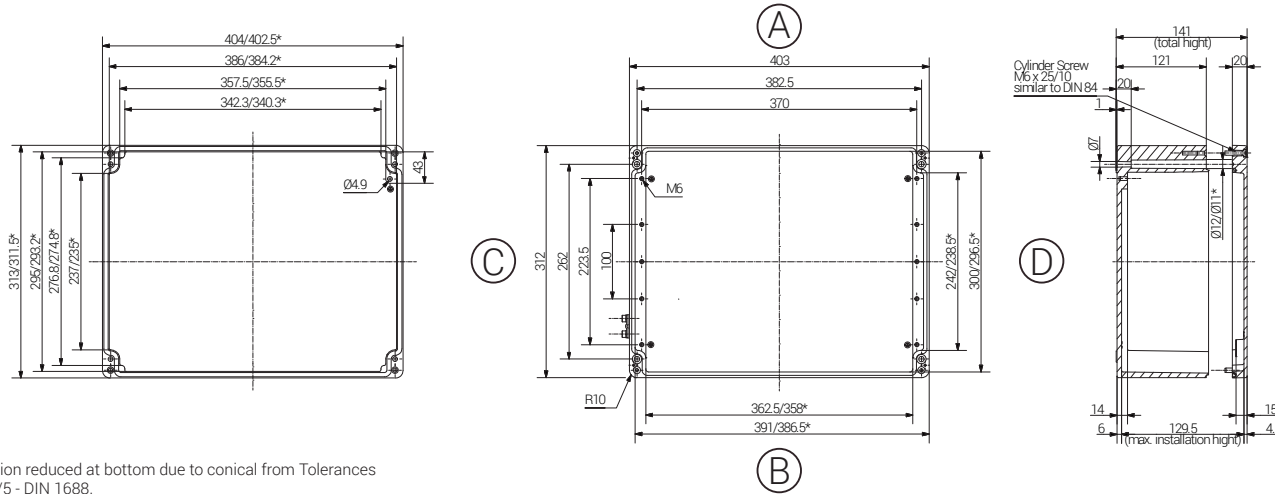

*= Dimension reduced at bottom due to conical from Tolerances to GTA 13/5 - DIN 1688.

www	Article		Length (mm)	Width (mm)	Height (mm)	DIN Rail for Terminals		PE busbar	PE angele brackets	Mounting Plate; galv. Sheet steel Thickness in mm	External Mounting Brackets in Set	External Hinge pair	Internal Hinges pair
	Aluminium Ex e	Aluminium Ex ia				TS15	TS35						
	15 403114 000	16 403114 000	400	310	140	-	X	2	-	2,0	X	X	X

Max. Bestückungsmöglichkeit für Kabelverschraubungen
 Max. assembly with cable glands

M	Eckmaß across corner	Seite / Side				PG	Eckmaß across corner	Seite / Side			
		A	B	C	D			A	B	C	D
12	17,25	147	95	7	17,25	147	95				
16	25,30	70	43	9	21,85	96	55				
20	27,60	55	32	11	25,30	70	40				
25	37,95	28	18	13,5	27,60	55	32				
32	48,30	17	10	16	31,05	44	28				
40	60,95	12	7	21	37,95	27	18				
50	69,00	7	4	29	48,30	17	10				
63	74,75	6	3	36	60,95	12	7				
				42	69,00	7	4				
				48	74,75	6	3				

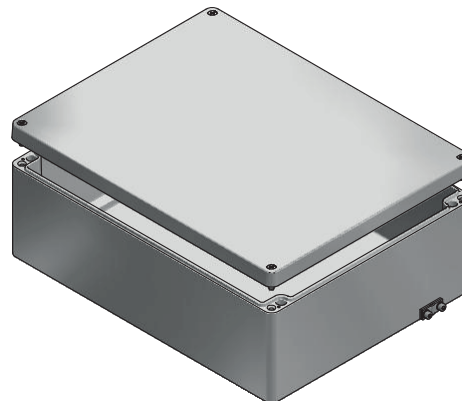

Gehäuse
 Enclosure
 EX-GEHÄUSE AL
 Ex e & Ex ia

Produktdokumentation
 Product Documentation



RST Rabe-System-Technik und Vertriebs-GmbH
 Otto-Lilienthal-Strasse 19
 49134 Wallenhorst

DEUTSCHLAND

+49 5407 8766-0
 +49 5407 8766-99
 info@rst.eu
 www.rst.eu