

Material	Aluminium
Farbton	RAL 7001
Dichtung	Silikon
Einsatztemperatur	-20°C bis +40°C - entspricht T6= +85°C Oberflächentemperatur (weitere auf Anfrage)
Schutzart	IP66

Material	Aluminium
Colour	RAL 7001
Sealing	Silicone
Operating Temperature	-20°C to +40°C - equal to T6 = +85°C surface temperature (Further on Request)
Protection Class	IP66

Für besondere Bedingungen oder Einschränkungen siehe entsprechende Produktdokumentation.

For specific conditions or limitations please see relevant product documentation.



Gehäuse  
Enclosure  
EX-GEHÄUSE AL  
Ex e & Ex ia  
160 x 100 x 80 mm

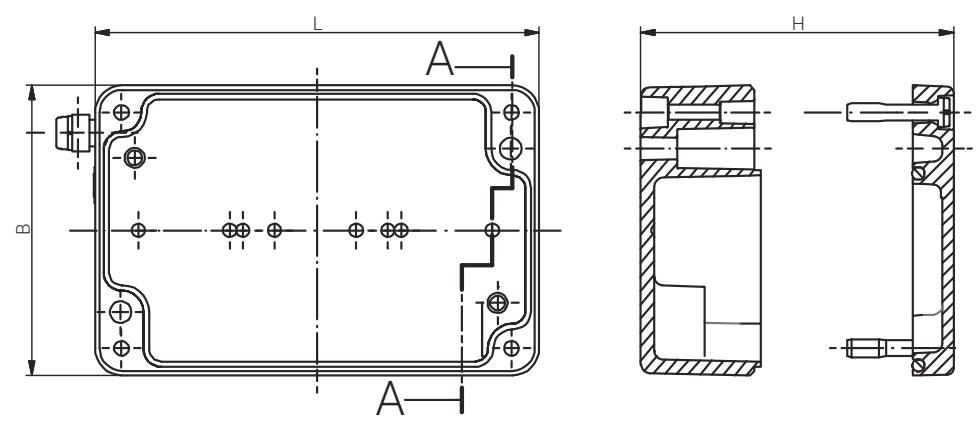

Schnitt A - A  
cutaway model A - A

Produktdokumentation  
Product Documentation



RST Rabe-System-Technik und Vertriebs-GmbH  
Otto-Lilienthal-Strasse 19  
49134 Wallenhorst  
DEUTSCHLAND  
☎ +49 5407 8766-0  
☎ +49 5407 8766-99  
✉ info@rst.eu  
🌐 www.rst.eu

	Artikel Article	Artikel Article		
Aluminium Ex e	Gewicht / Weight kg	Aluminium Ex ia	Gewicht / Weight kg	
15 161008 000	1,000	16 161008 000	1,000	

Material	Aluminium
Farbton	RAL 7001
Dichtung	Silikon
Einsatztemperatur	-20°C bis +40°C - entspricht T6= +85°C Oberflächentemperatur (weitere auf Anfrage)
Schutzart	IP66

Material	Aluminium
Colour	RAL 7001
Sealing	Silicone
Operating Temperature	-20°C to +40°C - equal to T6 = +85°C surface temperature (Further on Request)
Protection Class	IP66

Für besondere Bedingungen oder Einschränkungen siehe entsprechende Produktdokumentation.

For specific conditions or limitations please see relevant product documentation.

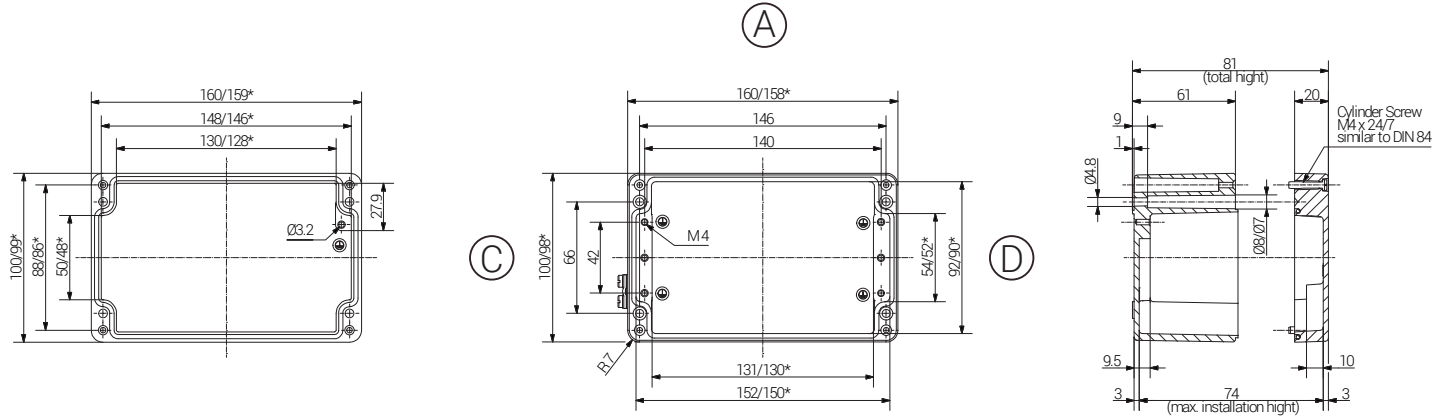

\*= Dimension reduced at bottom due to conical from Tolerances to GTA 13/5 - DIN 1688.

www	Article		Length (mm)	Width (mm)	Height (mm)	DIN Rail for Terminals		PE busbar	PE angele brackets	Mounting Plate; galv. Sheet steel Thickness in mm	External Mounting Brackets in Set	External Hinge pair	Internal Hinges pair
	Aluminium Ex e	Aluminium Ex ia				TS15	TS35						
15 161008 000	16 161008 000	160	100	80	X	X	-	-	1,5	X	X	-	

Max. Bestückungsmöglichkeit für Kabelverschraubungen  
Max. assembly with cable glands

M	Eckmaß across corner	Seite / Side				PG	Eckmaß across corner	Seite / Side			
		A	B	C	D			A	B	C	D
12	17,25	24	9	7	17,25	22	8				
16	25,30	11	4	9	21,85	17	5				
20	27,60	10	3	11	25,30	11	4				
25	37,95	4	1	13,5	27,60	10	3				
32	48,30	3	1	16	31,05	8	2				
40	60,95			21	37,95	4	1				
50	69,00			29	48,30	3	1				
63	74,75			36	60,95						
				42	69,00						
				48	74,75						

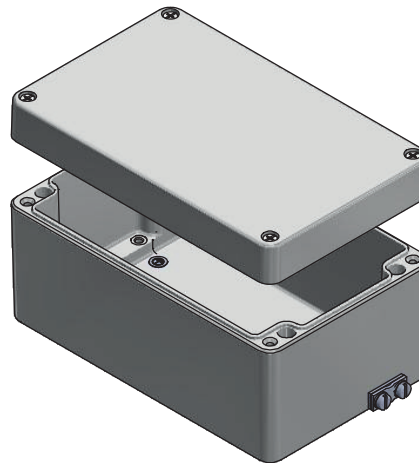

Gehäuse  
Enclosure  
EX-GEHÄUSE AL  
Ex e & Ex ia

Produktdokumentation  
Product Documentation



RST Rabe-System-Technik und Vertriebs-GmbH  
Otto-Lilienthal-Strasse 19  
49134 Wallenhorst

DEUTSCHLAND

+49 5407 8766-0  
+49 5407 8766-99  
info@rst.eu  
www.rst.eu