

Artikelnummer RST
Article Code RST

Gewinde
Entry Thread



Di
(mm)

L
(mm)

H
(mm)

VPE *
PU *

AG / Male

IG / Female

61092016

M20x1.5

PG 16

24

15.0

6.0

13.5

50

Material
Schutzart
Zolltarif-Nummer
Gewicht
EAN-Nummer
RoHS (2015/863/EU)
REACH/SVHC (Art. 33 1907/2006)
Konfliktmineralien (Dodd-Frank Act)

Messing, vernickelt
Abhängig von der Kombination mit weiteren Komponenten.
74198090
4054838002503
konf. (Inanspruchnahme Ausnahme 6c)
Blei enthalten
keine Konfliktmineralien enthalten

Material
Protection Class
Customs Tariff Number
Weight
EAN Code
RoHS (2015/863/EU)
REACH/SVHC (Art. 33 1907/2006)
Konfliktmineralien (Dodd-Frank Act)

Nickel Plated Brass
Depending on the combination with further components.
74198090
4054838002503
compliant (claim exception 6c)
contain lead
contain no conflict minerals



Zubehör
Accessories
ADAPTER SECHSKANT
M x PG
ADAPTER HEXAGON
M x PG

Produktdokumentation
Product Documentation

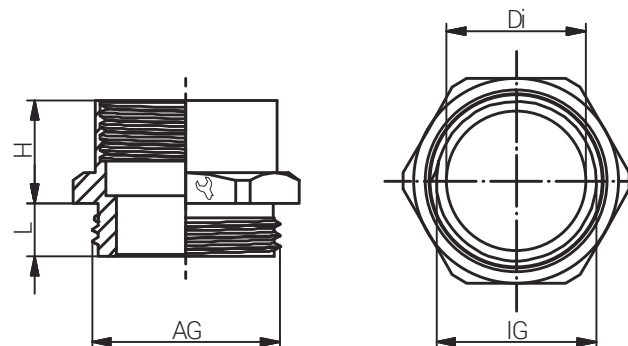
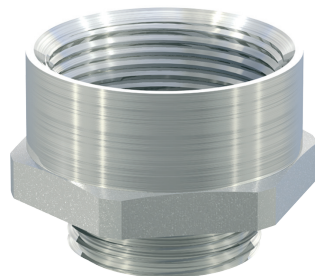

* Mindestbestellmenge (MOQ) kann größer sein als Verpackungseinheit (VPE).
* Minimum order quantity (MOQ) can be larger than packaging unit (PU).

RST Rabe-System-Technik und Vertriebs-GmbH
Otto-Lilienthal-Strasse 19
49134 Wallenhorst

DEUTSCHLAND

+49 5407 8766-0
+49 5407 8766-99
info@rst.eu
www.rst.eu