

Artikelnummer RST Article Code RST	Herstellernummer Manufacturer Code	Gewinde Entry Thread		B (mm)	L (mm)	H (mm)	H1 (mm)	VPE* PU*
		AG / Male	IG / Female					
FGA1312YXN	FGA1312YXN	M25x1.5	M20x1.5	35.0	17.0	57.0	50.0	1

Material: Messing, vernickelt
 Schutzart gem. IEC 60529: IP66/IP68
 ATEX-Kenzeichnung: Ex II2 GD / Ex d IIC Gb / Ex e IIC Gb / Ex tb IIIC Db
 Ex I M2 / Ex d I Mb / Ex e I Mb
 Empfohlenes Anzugsdrehmoment: Stutzen siehe Montageanleitung
 CE-Kennzeichnung: ja (Richtlinie 2014/34/EU)
 Zolltarif-Nummer: 74198090
 Gewicht: konf. (Inanspruchnahme Ausnahme 6c)
 RoHS (2015/863/EU): Blei enthalten
 REACH/SVHC (Art. 33 1907/2006): keine Konfliktminerale enthalten
 Konfliktminerale (Dodd-Frank Act): keine Konfliktminerale enthalten

Material: Nickel Plated Brass
 Protection Class rel. IEC 60529: IP66/IP68
 ATEX Marking: Ex II2 GD / Ex d IIC Gb / Ex e IIC Gb / Ex tb IIIC Db
 Ex I M2 / Ex d I Mb / Ex e I Mb
 Recommended Tightening Torque: Body see assembly instruction
 CE Marking: yes (Directive 2014/34/EU)
 Customs Tariff Number: 74198090
 Weight: compliant (claim exception 6c)
 RoHS (2015/863/EU): contain lead
 REACH/SVHC (Art. 33 1907/2006): contain no conflict minerals
 Konfliktminerale (Dodd-Frank Act): contain no conflict minerals

Für besondere Bedingungen oder Einschränkungen siehe entsprechende Produktdokumentation.

For specific conditions or limitations please see relevant product documentation.

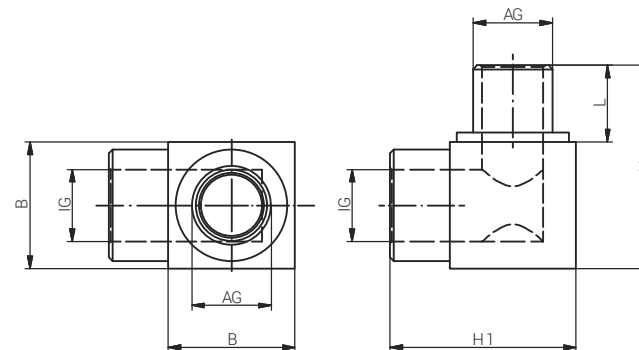

Zubehör

Accessories

ADAPTER 90° / M x M

ADAPTER 90° / M x M

Produktdokumentation
Product Documentation



* Mindestbestellmenge (MOQ) kann größer sein als Verpackungseinheit (VPE).
 * Minimum order quantity (MOQ) can be larger than packaging unit (PU).

RST Rabe-System-Technik und Vertriebs-GmbH
 Otto-Lilienthal-Strasse 19
 49134 Wallenhorst

DEUTSCHLAND

+49 5407 8766-0
 +49 5407 8766-99
 info@rst.eu
 www.rst.eu