

Artikelnummer RST Article Code RST	Herstellernummer Manufacturer Code	Gewinde Entry Thread		B (mm)	L (mm)	H (mm)	H1 (mm)	VPE* PU*
		AG / Male	IG / Female					
FGE1313Y	FGE1313Y	M25x1.5	M25x1.5	35.0	17.0	57.0	50.0	1

Material	Edelstahl 1.4404
Schutzart gem. IEC 60529	IP66/IP68
ATEX-Kenzeichnung	Ex II2 GD / Ex d IIC Gb / Ex e IIC Gb / Ex tb IIIC Db
Empfohlenes Anzugsdrehmoment	Ex I M2 / Ex d I Mb / Ex e I Mb Stutzen siehe Montageanleitung
CE-Kennzeichnung	ja (Richtlinie 2014/34/EU)
Zolltarif-Nummer	73269098
Gewicht	0.256 kg
RoHS (2015/863/EU)	konform
REACH/SVHC (Art. 33 1907/2006)	keine SVHC-Stoffe enthalten
Konfliktmineralien (Dodd-Frank Act)	keine Konfliktmineralien enthalten

Material	Stainless Steel 316L
Protection Class rel. IEC 60529	IP66/IP68
ATEX Marking	Ex II2 GD / Ex d IIC Gb / Ex e IIC Gb / Ex tb IIIC Db
Recommended Tightening Torque	Ex I M2 / Ex d I Mb / Ex e I Mb Body see assembly instruction
CE Marking	yes (Directive 2014/34/EU)
Customs Tariff Number	73269098
Weight	0.256 kg
RoHS (2015/863/EU)	compliant
REACH/SVHC (Art. 33 1907/2006)	contain no SVHC substances
Konfliktmineralien (Dodd-Frank Act)	contain no conflict minerals

Für besondere Bedingungen oder Einschränkungen siehe entsprechende Produktdokumentation.

For specific conditions or limitations please see relevant product documentation.

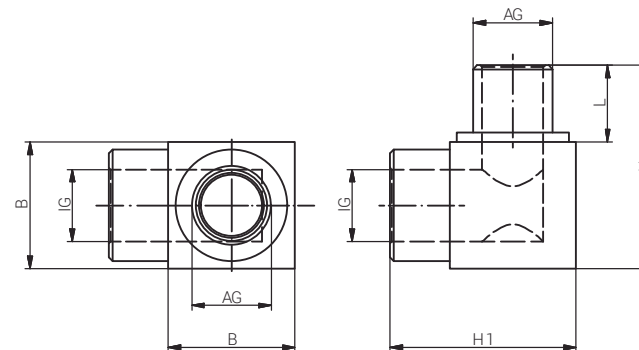

Zubehör

Accessories

ADAPTER 90° / M x M

ADAPTER 90° / M x M

Produktdokumentation
Product Documentation



* Mindestbestellmenge (MOQ) kann größer sein als Verpackungseinheit (VPE).

* Minimum order quantity (MOQ) can be larger than packaging unit (PU).

RST Rabe-System-Technik und Vertriebs-GmbH
Otto-Lilienthal-Strasse 19
49134 Wallenhorst

DEUTSCHLAND

+49 5407 8766-0

+49 5407 8766-99

info@rst.eu

www.rst.eu