

Artikelnummer RST Article Code RST	Herstellernummer Manufacturer Code	Membrantyp Membrane Type	Luftdurchlass Air Flow $\Delta P = 70 \text{ mbar}$ l/h (mind.)	Gewinde Entry Thread		L (mm)	H (mm)	D (mm)	VPE * PU *
RAL7035	RAL7035								
11087506G2	MBVPG-11	M	8	M6x0.75	10	10.0	6.15	11.0	1

Material	Polyamid 6
Membran	Acryl-CoPolymer
O-Ring	NBR 4x1.0
Einsatztemperatur	-40°C bis +100°C
Entflammbarkeit (Polyamid 6)	UL-94 (V-2)
Entflammbarkeit (NBR)	UL-94 (HB)
Schutzart gem. IEC 60529	IP66/IP68/IP69k
Empfohlenes Anzugsdrehmoment	Stutzen 0.3 Nm
CE-Kennzeichnung	nein
Zolltarif-Nummer	39269097
Gewicht	0.001 kg
EAN-Nummer	4054838012359
RoHS (2015/863/EU)	konform
REACH/SVHC (Art. 33 1907/2006)	keine SVHC-Stoffe enthalten
Konfliktminerale (Dodd-Frank Act)	keine Konfliktminerale enthalten

Für besondere Bedingungen oder Einschränkungen siehe entsprechende Produktdokumentation.

Material	Polyamide 6
Membrane	Acryl-CoPolymer
O-Ring	NBR 4x1.0
Operating Temperature	-40°C to +100°C
Flammability (Polyamide 6)	UL-94 (V-2)
Flammability (NBR)	UL-94 (HB)
Protection Class rel. IEC 60529	IP66/IP68/IP69k
Recommended Tightening Torque	Body 0.3 Nm
CE Marking	no
Customs Tariff Number	39269097
Weight	0.001 kg
EAN Code	4054838012359
RoHS (2015/863/EU)	compliant
REACH/SVHC (Art. 33 1907/2006)	contain no SVHC substances
Konfliktminerale (Dodd-Frank Act)	contain no conflict minerals

For specific conditions or limitations please see relevant product documentation.

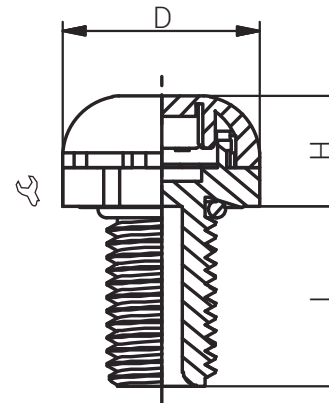
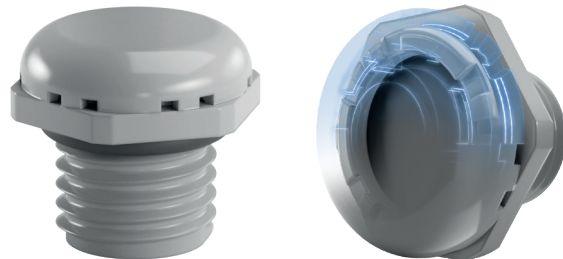

Druckausgleichs- lösungen Pressure Equalisation Solutions DAE 2. GEN. / M

Produktdokumentation Product Documentation



* Mindestbestellmenge (MOQ) kann größer sein als Verpackungseinheit (VPE).

* Minimum order quantity (MOQ) can be larger than packaging unit (PU).

RST Rabe-System-Technik und Vertriebs-GmbH
Otto-Lilienthal-Strasse 19
49134 Wallenhorst

DEUTSCHLAND

+49 5407 8766-0

+49 5407 8766-99

info@rst.eu

www.rst.eu