

Artikelnummer RST Article Code RST	Herstellernummer Manufacturer Code	Gewinde Entry Thread	Klemmbereich Clamping Range (mm)		 1/2	L (mm)	H max. (mm)	VPE * PU *
			≥	≤				
63080516	BDSM-01	M16x1.5	4.0	9.0	18/18	5.1	18.5	50

Material	Messing, vernickelt
Dichteinsatz	NBR
O-Ring	NBR
Einsatztemperatur	-40°C bis +100°C kurzzeitig -40°C bis +150°C
Entflammbarkeit (NBR)	UL-94 (HB)
Schutzart gem. IEC 60529	IP68 (5bar/30Min.)
Empfohlenes Anzugsdrehmoment	Hutmutter Stutzen Einzelichtung S1 4.0 Nm 15.0 Nm Doppeldichtung S1+S2 18.0 Nm
CE-Kennzeichnung	ja (Richtlinie 2014/35/EU)
Zolltarif-Nummer	74198090
Gewicht	0.021 kg
RoHS (2015/863/EU)	konf. (Inanspruchnahme Ausnahme 6c)
REACH/SVHC (Art. 33 1907/2006)	Blei enthalten
Konfliktminerale (Dodd-Frank Act)	keine Konfliktminerale enthalten

Material	Nickel Plated Brass
Sealing	NBR
O-Ring	NBR
Operating Temperature	-40°C to +100°C intermittent -40°C to +150°C
Flammability (NBR)	UL-94 (HB)
Protection Class rel. IEC 60529	IP68 (5bar/30min.)
Recommended Tightening Torque	Cap Body Single Sealing S1 4.0 Nm 15.0 Nm Double Sealing S1+S2 18.0 Nm
CE Marking	yes (Directive 2014/35/EU)
Customs Tariff Number	74198090
Weight	0.021 kg
RoHS (2015/863/EU)	compliant (claim exception 6c)
REACH/SVHC (Art. 33 1907/2006)	contain lead
Konfliktminerale (Dodd-Frank Act)	contain no conflict minerals

Für besondere Bedingungen oder Einschränkungen siehe entsprechende Produktdokumentation.

For specific conditions or limitations please see relevant product documentation.

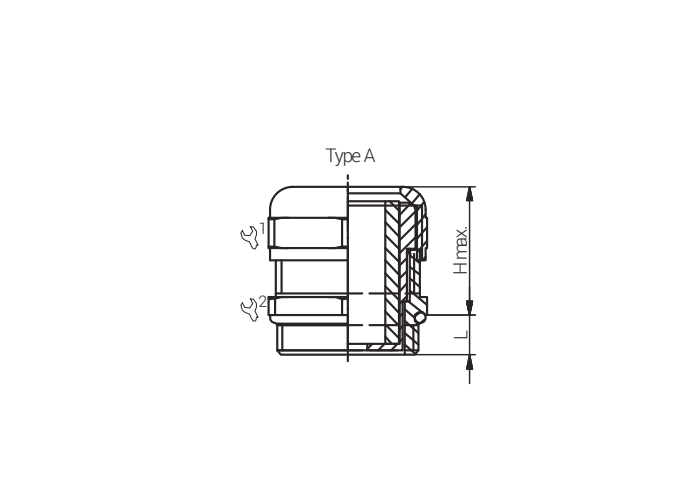

Kabelverschraubungen Standard Standard Cable Glands EURO-TIGHT / M

Produktdokumentation Product Documentation



* Mindestbestellmenge (MOQ) kann größer sein als Verpackungseinheit (VPE).
* Minimum order quantity (MOQ) can be larger than packaging unit (PU).

RST Rabe-System-Technik und Vertriebs-GmbH
Otto-Lilienthal-Strasse 19
49134 Wallenhorst
DEUTSCHLAND
 **+49 5407 8766-0**
 **+49 5407 8766-99**
 **info@rst.eu**
 **www.rst.eu**