

Artikelnummer RST Article Code RST	Herstellernummer Manufacturer Code	Gewinde Entry Thread	Klemmbereich Clamping Range (mm)		 1/2	L (mm)	H max. (mm)	VPE * PU *
			≥	≤				
RAL7035	RAL7035							
11380421	50021PABS7035	PG 21	13.0	18.0	33/33	11.0	130.0	25

Material	Polyamid 6
Dichteinsatz	Polychloropren-Nitrilkautschuk
Einsatztemperatur	-20°C bis +100°C
Entflammbarkeit (Polyamid 6)	UL-94 V2
Schutzart gem. IEC 60529	IP68
CE-Kennzeichnung	ja (Richtlinie 2014/35/EU)
Zolltarif-Nummer	39269097
Gewicht	0.043 kg
RoHS (2015/863/EU)	konform
REACH/SVHC (Art. 33 1907/2006)	keine SVHC-Stoffe enthalten
Konfliktminerale (Dodd-Frank Act)	keine Konfliktminerale enthalten

Material	Polyamide 6
Sealing	Polychloropren-Nitril Rubber
Operating Temperature	-20°C to +100°C
Flammability (Polyamide 6)	UL-94 V2
Protection Class rel. IEC 60529	IP68
CE Marking	yes (Directive 2014/35/EU)
Customs Tariff Number	39269097
Weight	0.043 kg
RoHS (2015/863/EU)	compliant
REACH/SVHC (Art. 33 1907/2006)	contain no SVHC substances
Konfliktminerale (Dodd-Frank Act)	contain no conflict minerals

Für besondere Bedingungen oder Einschränkungen siehe entsprechende Produktdokumentation.

For specific conditions or limitations please see relevant product documentation.

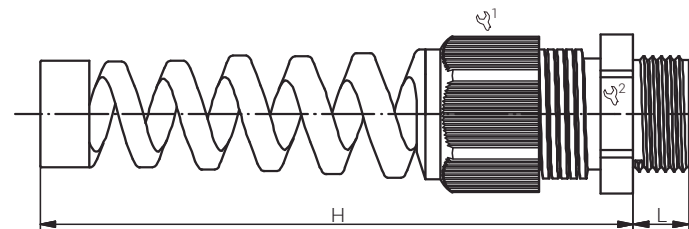
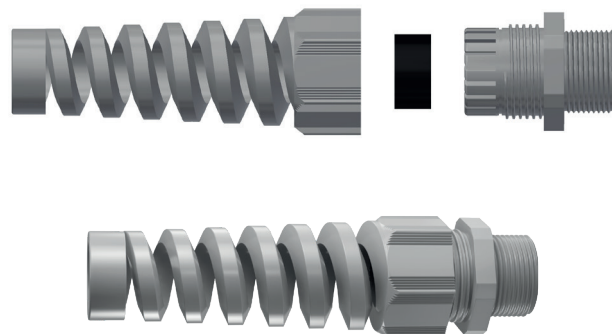

Kabelverschraubungen
Standard
Standard Cable Glands
EURO-TOP BIEGE-
SCHUTZ PA / M

Produktdokumentation
Product Documentation



* Mindestbestellmenge (MOQ) kann größer sein als Verpackungseinheit (VPE).
* Minimum order quantity (MOQ) can be larger than packaging unit (PU).

RST Rabe-System-Technik und Vertriebs-GmbH
Otto-Lilienthal-Strasse 19
49134 Wallenhorst

DEUTSCHLAND

+49 5407 8766-0

+49 5407 8766-99

info@rst.eu

www.rst.eu