

Artikelnummer RST Article Code RST	Herstellernummer Manufacturer Code	Gewinde Entry Thread	Klemmbereich Clamping Range (mm)		Klemmbereich Schirm Shield Diameter (mm)		 1/2	L (mm)	H max. (mm)	VPE * PU *
			≥	≤	≥	≤				
61084532LF	BMEM-E4 (LF)	M32x1.5	15.0	21.0	13.5	19.0	34/34	8.0	38.0	18

Material	Messing, vernickelt
Dichteinsatz	Chloropren
Klemmeinsatz	Polyamid 6
EMV-Kontaktfeder	Kupfer-Beryllium
Ring	Messing, vernickelt
O-Ring	NBR
Einsatztemperatur	-40°C bis +100°C kurzzeitig -40°C bis +150°C
Entflammbarkeit (Polyamid 6)	UL-94 (V-2)
Entflammbarkeit (Chloropren)	UL-94 (HB)
Entflammbarkeit (NBR)	UL-94 (HB)
Schutzart gem. IEC 60529	IP66/IP68 (5bar/30 Min.)/IP69k
Schutzart gem. UL50E	4X/12/13
Zugentlastung gem. EN 62444:2013	Kat. A
Kat. der Schlägeinw. gem. EN 62444:2013	4 (2.0 Joule)
Empfohlenes Anzugsdrehmoment	Hutmutter 15.0 Nm Stutzen 8.0 Nm
CE-Kennzeichnung	ja (Richtlinie 2014/35/EU)
Zolltarif-Nummer	85369010
Gewicht	0.088 kg
RoHS (2015/863/EU)	konform
REACH/SVHC (Art. 33 1907/2006)	keine SVHC-Stoffe enthalten
Konfliktminerale (Dodd-Frank Act)	keine Konfliktminerale enthalten

Für besondere Bedingungen oder Einschränkungen siehe entsprechende Produktdokumentation.

Material	Nickel Plated Brass
Sealing	Chloroprene
Clamping Insert	Polyamide 6
EMC Contact Spring	Copper Beryllium
Ring	Nickel Plated Brass
O-Ring	NBR
Operating Temperature	-40°C to +100°C intermittent -40°C to +150°C
Flammability (Polyamide 6)	UL-94 (V-2)
Flammability (Chloroprene)	UL-94 (HB)
Flammability (NBR)	UL-94 (HB)
Protection Class rel. IEC 60529	IP66/IP68 (5bar/30 min.)/IP69k
Protection Class rel. UL50E	4X/12/13
Strain relief rel. EN 62444:2013	Cat. A
Impact Category rel. EN 62444:2013	4 (2.0 Joule)
Recommended Tightening Torque	Cap 15.0 Nm Body 8.0 Nm
CE Marking	yes (Directive 2014/35/EU)
Customs Tariff Number	85369010
Weight	0.088 kg
RoHS (2015/863/EU)	compliant
REACH/SVHC (Art. 33 1907/2006)	contain no SVHC substances
Konfliktminerale (Dodd-Frank Act)	contain no conflict minerals

For specific conditions or limitations please see relevant product documentation.

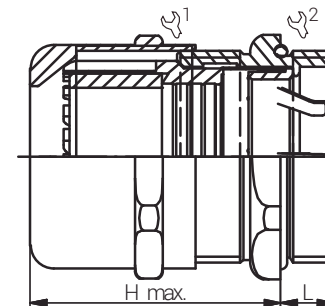

Kabelverschraubungen EMV EMC Cable Glands EURO-TOP EMV 3. Gen. LF M

Produktdokumentation Product Documentation



* Mindestbestellmenge (MOQ) kann größer sein als Verpackungseinheit (VPE).

* Minimum order quantity (MOQ) can be larger than packaging unit (PU).

RST Rabe-System-Technik und Vertriebs-GmbH
Otto-Lilienthal-Strasse 19
49134 Wallenhorst

DEUTSCHLAND

+49 5407 8766-0

+49 5407 8766-99

info@rst.eu

www.rst.eu