

Artikelnummer RST Article Code RST	Herstellernummer Manufacturer Code	Gewinde Entry Thread	Klemmbereich Clamping Range (mm)		Klemmbereich Schirm Shield Diameter (mm)		 1/2	L (mm)	H max. (mm)	VPE * PU *
			≥	≤	≥	≤				
R61086522	R-BMEM-E2 (M20T)	M20x1.5	7.5	14.0	5.5	11.5	24/24	8.0	41.5	50

Material	Messing, vernickelt
Dichteinsatz	EDPM
Klemmeinsatz	Polyamid 6
EMV-Kontaktfeder	Kupfer-Beryllium
Ring	Messing, vernickelt
O-Ring	EPDM
Einsatztemperatur	-40°C bis +100°C
Entflammbarkeit (Polyamid 6)	UL-94 (V-2)
Schutzart gem. IEC 60529	IP66/IP68
Kat. der Schlageinw. gem. EN 62444:2013	2 (0.5 Joule)
Empfohlenes Anzugsdrehmoment	Hutmutter 10.0 Nm Stutzen 6.0 Nm
CE-Kennzeichnung	ja (Richtlinie 2014/35/EU)
Zolltarif-Nummer	85369010
Gewicht	0.048 kg
RoHS (2015/863/EU)	konf. (Inanspruchnahme Ausnahme 6c)
REACH/SVHC (Art. 33 1907/2006)	Blei enthalten
Konfliktminerale (Dodd-Frank Act)	keine Konfliktminerale enthalten

Material	Nickel Plated Brass
Sealing	EDPM
Clamping Insert	Polyamide 6
EMC Contact Spring	Copper Beryllium
Ring	Nickel Plated Brass
O-Ring	EPDM
Operating Temperature	-40°C to +100°C
Flammability (Polyamide 6)	UL-94 (V-2)
Protection Class rel. IEC 60529	IP66/IP68
Impact Category rel. EN 62444:2013	2 (0.5 Joule)
Recommended Tightening Torque	Cap 10.0 Nm Body 6.0 Nm
CE Marking	yes (Directive 2014/35/EU)
Customs Tariff Number	85369010
Weight	0.048 kg
RoHS (2015/863/EU)	compliant (claim exception 6c)
REACH/SVHC (Art. 33 1907/2006)	contain lead
Konfliktminerale (Dodd-Frank Act)	contain no conflict minerals

Für besondere Bedingungen oder Einschränkungen siehe entsprechende Produktdokumentation.

For specific conditions or limitations please see relevant product documentation.

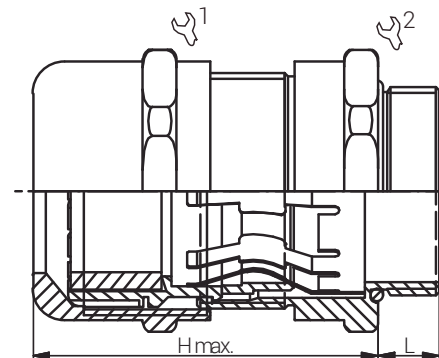

Kabelverschraubungen EMV EMC Cable Glands EURO-TOP EMV 4 RAIL / M

Produktdokumentation Product Documentation



* Mindestbestellmenge (MOQ) kann größer sein als Verpackungseinheit (VPE).

* Minimum order quantity (MOQ) can be larger than packaging unit (PU).

RST Rabe-System-Technik und Vertriebs-GmbH
Otto-Lilienthal-Strasse 19
49134 Wallenhorst

DEUTSCHLAND

+49 5407 8766-0

+49 5407 8766-99

info@rst.eu

www.rst.eu