

Artikelnummer RST Article Code RST	Herstellernummer Manufacturer Code	Gewinde Entry Thread	Klemmbereich Clamping Range (mm)		 1/2	L (mm)	H max. (mm)	VPE * PU *
			≥	≤				
90180520	BMSD-02	M20x1.5	5.0	9.0	22/22	8.0	24.0	50

Material	Edelstahl 1.4305	
Dichteinsatz	Chloropren	
Klemmeinsatz	Polyamid 6	
O-Ring	NBR	
Einsatztemperatur	-40°C bis +100°C kurzzeitig -40°C bis +150°C	
Entflammbarkeit gem. UL-94 (Polyamid 6)	V-2	
Entflammbarkeit gem. UL-94 (Chloropren)	HB	
Entflammbarkeit gem. UL-94 (NBR)	HB	
Schutzart gem. IEC 60529	IP66/IP68/IP69	
Zugentlastung gem. EN 62444:2013	Kat. A	
Kat. der Schlägeinw. gem. EN 62444:2013	2 (0.5 Joule)	
Empfohlenes Anzugsdrehmoment	Hutmutter 9.5 Nm	Stutzen 5.5 Nm
CE-Kennzeichnung	ja (Richtlinie 2014/35/EU)	
Zolltarif-Nummer	73269098	
Gewicht	0.026 kg	
EAN-Nummer	4054838011215	
RoHS (2015/863/EU)	konform	
REACH/SVHC (Art. 33 1907/2006)	keine SVHC-Stoffe enthalten	
Konfliktminerale (Dodd-Frank Act)	keine Konfliktminerale enthalten	

Für besondere Bedingungen oder Einschränkungen siehe entsprechende Produktdokumentation.

Material	Stainless Steel 303	
Sealing	Chloroprene	
Clamping Insert	Polyamide 6	
O-Ring	NBR	
Operating Temperature	-40°C to +100°C intermittent -40°C to +150°C	
Flammability rel. UL-94 (Polyamide 6)	V-2	
Flammability rel. UL-94 (Chloroprene)	HB	
Flammability rel. UL-94 (NBR)	HB	
Protection Class rel. IEC 60529	IP66/IP68/IP69	
Strain relief rel. EN 62444:2013	Cat. A	
Impact Category rel. EN 62444:2013	2 (0.5 Joule)	
Recommended Tightening Torque	Cap 9.5 Nm	Body 5.5 Nm
CE Marking	yes (Directive 2014/35/EU)	
Customs Tariff Number	73269098	
Weight	0.026 kg	
EAN Code	4054838011215	
RoHS (2015/863/EU)	compliant	
REACH/SVHC (Art. 33 1907/2006)	contain no SVHC substances	
Konfliktminerale (Dodd-Frank Act)	contain no conflict minerals	

For specific conditions or limitations please see relevant product documentation.

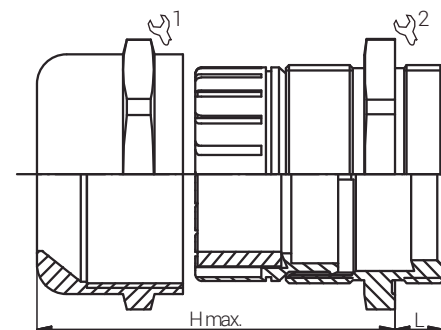

Kabelverschraubungen Standard Standard Cable Glands EURO-TOP ES / M with Reducing Sealing

Produktdokumentation Product Documentation



* Mindestbestellmenge (MOQ) kann größer sein als Verpackungseinheit (VPE).

* Minimum order quantity (MOQ) can be larger than packaging unit (PU).

RST Rabe-System-Technik und Vertriebs-GmbH
Otto-Lilienthal-Strasse 19
49134 Wallenhorst

DEUTSCHLAND

+49 5407 8766-0

+49 5407 8766-99

info@rst.eu

www.rst.eu