

| Artikelnummer RST Article Code RST | Herstellernummer Manufacturer Code | Gewinde Entry Thread | Klemmbereich Clamping Range (mm) | |  1/2 | L (mm) | H max. (mm) | VPE * PU * |
|---------------------------------------|---------------------------------------|-------------------------|--|------|--|-----------|----------------|---------------|
| | | | ≥ | ≤ | | | | |
| 90080540 | BMSC-05 | M40x1.5 | 18.0 | 25.0 | 41/46 | 9.0 | 40.6 | 10 |

| | | |
|---|---|--------------------|
| Material | Edelstahl 1.4305 | |
| Dichteinsatz | Chloropren | |
| Klemmeinsatz | Polyamid 6 | |
| O-Ring | NBR | |
| Einsatztemperatur | -40°C bis +100°C kurzzeitig -40°C bis +150°C | |
| Entflammbarkeit gem. UL-94 (Polyamid 6) | V-2 | |
| Entflammbarkeit gem. UL-94 (Chloropren) | HB | |
| Entflammbarkeit gem. UL-94 (NBR) | HB | |
| Schutzart gem. IEC 60529 | IP66/IP68/IP69 | |
| Schutzart gem. UL50E | 1/4/4X/12/13 | |
| Zugentlastung gem. EN 62444:2013 | Kat. A | |
| Kat. der Schlägeinw. gem. EN 62444:2013 | 4 (2.0 Joule) | |
| Empfohlenes Anzugsdrehmoment | Hutmutter 30.0 Nm | Stutzen 12.0 Nm |
| CE-Kennzeichnung | ja (Richtlinie 2014/35/EU) | |
| Zolltarif-Nummer | 73269098 | |
| Gewicht | 0.135 kg | |
| EAN-Nummer | 4054838011307 | |
| RoHS (2015/863/EU) | konform | |
| REACH/SVHC (Art. 33 1907/2006) | keine SVHC-Stoffe enthalten | |
| Konfliktminerale (Dodd-Frank Act) | keine Konfliktminerale enthalten | |

Für besondere Bedingungen oder Einschränkungen siehe entsprechende Produktdokumentation.

| | | |
|---------------------------------------|---|-----------------|
| Material | Stainless Steel 303 | |
| Sealing | Chloroprene | |
| Clamping Insert | Polyamide 6 | |
| O-Ring | NBR | |
| Operating Temperature | -40°C to +100°C intermittent -40°C to +150°C | |
| Flammability rel. UL-94 (Polyamide 6) | V-2 | |
| Flammability rel. UL-94 (Chloroprene) | HB | |
| Flammability rel. UL-94 (NBR) | HB | |
| Protection Class rel. IEC 60529 | IP66/IP68/IP69 | |
| Protection Class rel. UL50E | 1/4/4X/12/13 | |
| Strain relief rel. EN 62444:2013 | Cat. A | |
| Impact Category rel. EN 62444:2013 | 4 (2.0 Joule) | |
| Recommended Tightening Torque | Cap 30.0 Nm | Body 12.0 Nm |
| CE Marking | yes (Directive 2014/35/EU) | |
| Customs Tariff Number | 73269098 | |
| Weight | 0.135 kg | |
| EAN Code | 4054838011307 | |
| RoHS (2015/863/EU) | compliant | |
| REACH/SVHC (Art. 33 1907/2006) | contain no SVHC substances | |
| Konfliktminerale (Dodd-Frank Act) | contain no conflict minerals | |

For specific conditions or limitations please see relevant product documentation.

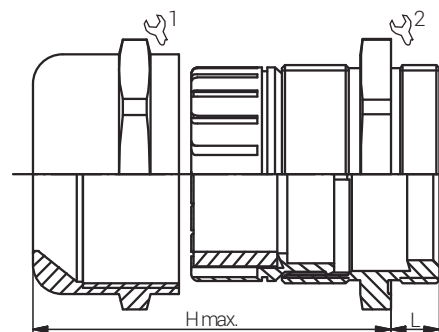

Kabelverschraubungen Standard Standard Cable Glands EURO-TOP ES / M

Produktdokumentation Product Documentation



* Mindestbestellmenge (MOQ) kann größer sein als Verpackungseinheit (VPE).

* Minimum order quantity (MOQ) can be larger than packaging unit (PU).

RST Rabe-System-Technik und Vertriebs-GmbH
Otto-Lilienthal-Strasse 19
49134 Wallenhorst

DEUTSCHLAND

+49 5407 8766-0

+49 5407 8766-99

info@rst.eu

www.rst.eu