

Artikelnummer RST Article Code RST	Herstellernummer Manufacturer Code	Gewinde Entry Thread	Klemmbereich Clamping Range (mm)		 1/2	L (mm)	H max. (mm)	VPE * PU *
			≥	≤				
RAL7035	RAL7035							
11084532HP	BHPM-14	M32x1.5	15.0	21.0	36/36	10.0	39.8	25

Material	Polyamid 6	
Dichteinsatz	Chloropren	
O-Ring	Chloropren	
Einsatztemperatur	-40°C bis +100°C kurzzeitig -60°C bis +150°C	
Entflammbarkeit (Polyamid 6)	UL-94 (V-2)	
Entflammbarkeit (Chloropren)	UL-94 (HB)	
Schutzart gem. IEC 60529	IP66/IP68(10bar/30Min.)/IP69k	
Zugentlastung gem. EN 62444:2013	Cat. B	
Kat. der Schlägeinw. gem. EN 62444:2013	4 (2.0 Joule)	
Empfohlenes Anzugsdrehmoment	Hutmutter 8.0 Nm	Stutzen 5.0 Nm
CE-Kennzeichnung	ja (Richtlinie 2014/35/EU)	
Zolltarif-Nummer	39269097	
Gewicht	0.030 kg	
RoHS (2015/863/EU)	konform	
REACH/SVHC (Art. 33 1907/2006)	keine SVHC-Stoffe enthalten	
Konfliktminerale (Dodd-Frank Act)	keine Konfliktminerale enthalten	

Material	Polyamide 6	
Sealing	Chloroprene	
O-Ring	Chloroprene	
Operating Temperature	-40°C to +100°C intermittent -60°C to +150°C	
Flammability (Polyamide 6)	UL-94 (V-2)	
Flammability (Chloroprene)	UL-94 (HB)	
Protection Class rel. IEC 60529	IP66/IP68(10bar/30min.)/IP69k	
Strain relief rel. EN 62444:2013	Cat. B	
Impact Category rel. EN 62444:2013	4 (2.0 Joule)	
Recommended Tightening Torque	Cap 8.0 Nm	Body 5.0 Nm
CE Marking	yes (Directive 2014/35/EU)	
Customs Tariff Number	39269097	
Weight	0.030 kg	
RoHS (2015/863/EU)	compliant	
REACH/SVHC (Art. 33 1907/2006)	contain no SVHC substances	
Konfliktminerale (Dodd-Frank Act)	contain no conflict minerals	

Für besondere Bedingungen oder Einschränkungen siehe entsprechende Produktdokumentation.

For specific conditions or limitations please see relevant product documentation.

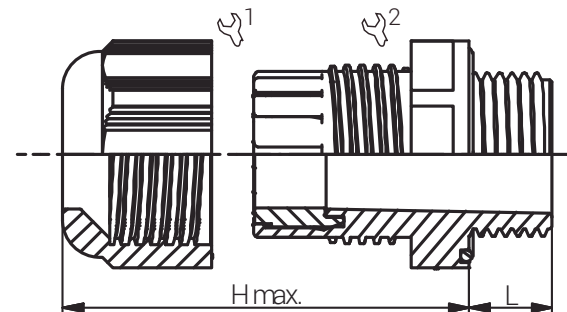
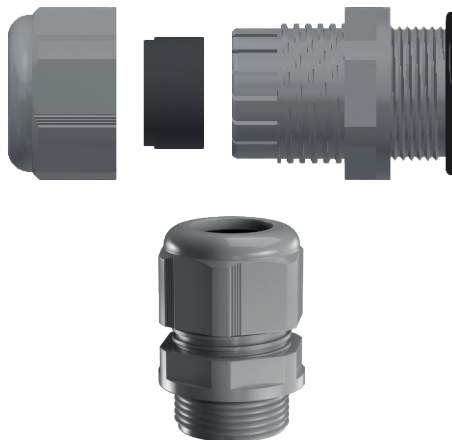

## Kabelverschraubungen Standard Standard Cable Glands EURO-TOP HP PA / M

## Produktdokumentation Product Documentation



\* Mindestbestellmenge (MOQ) kann größer sein als Verpackungseinheit (VPE).

\* Minimum order quantity (MOQ) can be larger than packaging unit (PU).

**RST Rabe-System-Technik und Vertriebs-GmbH**  
Otto-Lilienthal-Strasse 19  
49134 Wallenhorst

DEUTSCHLAND

+49 5407 8766-0

+49 5407 8766-99

info@rst.eu

www.rst.eu