

Artikelnummer RST Article Code RST	Herstellernummer Manufacturer Code	Gewinde Entry Thread	Klemmbereich Clamping Range (mm)		 1/2	L (mm)	H max. (mm)	VPE * PU *
			≥	≤				
60080429LF	BSBC-07 (LF)	PG 29	18.0	25.0	40/40	8.0	40.5	8

Material	Messing, vernickelt (bleifrei) CuZn42	
Dichtensatz	Chloropren	
Klemmeinsatz	Polyamid 6	
O-Ring	NBR	
Einsatztemperatur	-40°C bis +100°C kurzzeitig - bis +150°C	
Entflammbarkeit (Polyamid 6)	UL-94 (V-2)	
Entflammbarkeit (Chloropren)	UL-94 (HB)	
Entflammbarkeit (NBR)	UL-94 (HB)	
Schutzart gem. IEC 60529	IP66/IP68/IP69 (5bar/30Min.)	
Schutzart gem. UL50E	4X/12/13	
Zugentlastung gem. EN 62444:2013*	Kat. A	
Kat. der Schlägeinw. gem. EN 62444:2013*	4 (2.0 Joule)	
Empfohlenes Anzugsdrehmoment	Hutmutter 30.0 Nm	Stutzen 15.0 Nm
CE-Kennzeichnung	ja (Richtlinie 2014/35/EU)	
Zolltarif-Nummer	74198090	
Gewicht	0.131 kg	
RoHS (2015/863/EU)	konform	
REACH/SVHC (Art. 33 1907/2006)	keine SVHC-Stoffe enthalten	
Konfliktminerale (Dodd-Frank Act)	keine Konfliktminerale enthalten	

Für besondere Bedingungen oder Einschränkungen siehe entsprechende Produktdokumentation.

Material	Nickel Plated Brass (lead free) CuZn42	
Sealing	Chloroprene	
Clamping Insert	Polyamide 6	
O-Ring	NBR	
Operating Temperature	-40°C to +100°C intermittent - to +150°C	
Flammability (Polyamide 6)	UL-94 (V-2)	
Flammability (Chloroprene)	UL-94 (HB)	
Flammability (NBR)	UL-94 (HB)	
Protection Class rel. IEC 60529	IP66/IP68/IP69 (5bar/30min.)	
Protection Class rel. UL50E	4X/12/13	
Strain relief rel. EN 62444:2013*	Cat. A	
Impact Category rel. EN 62444:2013*	4 (2.0 Joule)	
Recommended Tightening Torque	Cap 30.0 Nm	Body 15.0 Nm
CE Marking	yes (Directive 2014/35/EU)	
Customs Tariff Number	74198090	
Weight	0.131 kg	
RoHS (2015/863/EU)	compliant	
REACH/SVHC (Art. 33 1907/2006)	contain no SVHC substances	
Konfliktminerale (Dodd-Frank Act)	contain no conflict minerals	

For specific conditions or limitations please see relevant product documentation.

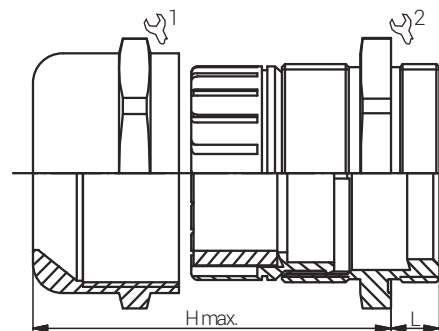

## Kabelverschraubungen Standard Standard Cable Glands EURO-TOP MS LF / PG



## Produktdokumentation Product Documentation



\* Mindestbestellmenge (MOQ) kann größer sein als Verpackungseinheit (VPE).  
\* Minimum order quantity (MOQ) can be larger than packaging unit (PU).

**RST Rabe-System-Technik und Vertriebs-GmbH**  
Otto-Lilienthal-Strasse 19  
49134 Wallenhorst

DEUTSCHLAND

+49 5407 8766-0  
+49 5407 8766-99  
info@rst.eu  
www.rst.eu