

Artikelnummer RST Article Code RST	Herstellernummer Manufacturer Code	Gewinde Entry Thread	Klemmbereich Clamping Range (mm)		 1/2	L (mm)	H max. (mm)	VPE * PU *
			≥	≤				
60080563	BMBC-07	M63x1.5	34.0	44.0	64/68	14.0	53.0	5

Material	Messing, vernickelt
Dichteinsatz	Chloropren
Klemmeinsatz	Polyamid 6
O-Ring	NBR
Einsatztemperatur	-40°C bis +100°C kurzzeitig -40°C bis +150°C
Entflammbarkeit (Polyamid 6)	UL-94 (V-2)
Entflammbarkeit (Chloropren)	UL-94 (HB)
Entflammbarkeit (NBR)	UL-94 (HB)
Schutzart gem. IEC 60529	IP66/IP68/IP69 (5bar/30Min.)
Schutzart gem. UL50E	4X/12/13
Zugentlastung gem. EN 62444:2013	Kat. A
Kat. der Schlägeinw. gem. EN 62444:2013	4 (2.0 Joule)
Empfohlenes Anzugsdrehmoment	Hutmutter 55.0 Nm Stutzen 25.0 Nm
CE-Kennzeichnung	ja (Richtlinie 2014/35/EU)
Zolltarif-Nummer	74198090
Gewicht	0.425 kg
EAN-Nummer	4054838010591
RoHS (2015/863/EU)	konf. (Inanspruchnahme Ausnahme 6c)
REACH/SVHC (Art. 33 1907/2006)	Blei enthalten
Konfliktminerale (Dodd-Frank Act)	keine Konfliktminerale enthalten

Für besondere Bedingungen oder Einschränkungen siehe entsprechende Produktdokumentation.

Material	Nickel Plated Brass
Sealing	Chloroprene
Clamping Insert	Polyamide 6
O-Ring	NBR
Operating Temperature	-40°C to +100°C intermittent -40°C to +150°C
Flammability (Polyamide 6)	UL-94 (V-2)
Flammability (Chloroprene)	UL-94 (HB)
Flammability (NBR)	UL-94 (HB)
Protection Class rel. IEC 60529	IP66/IP68/IP69 (5bar/30min.)
Protection Class rel. UL50E	4X/12/13
Strain relief rel. EN 62444:2013	Cat. A
Impact Category rel. EN 62444:2013	4 (2.0 Joule)
Recommended Tightening Torque	Cap 55.0 Nm Body 25.0 Nm
CE Marking	yes (Directive 2014/35/EU)
Customs Tariff Number	74198090
Weight	0.425 kg
EAN Code	4054838010591
RoHS (2015/863/EU)	compliant (claim exception 6c)
REACH/SVHC (Art. 33 1907/2006)	contain lead
Konfliktminerale (Dodd-Frank Act)	contain no conflict minerals

For specific conditions or limitations please see relevant product documentation.

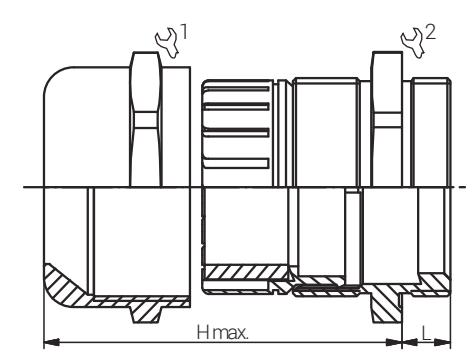

Kabelverschraubungen Standard Standard Cable Glands EURO-TOP MS / M

Produktdokumentation Product Documentation



* Mindestbestellmenge (MOQ) kann größer sein als Verpackungseinheit (VPE).
* Minimum order quantity (MOQ) can be larger than packaging unit (PU).

RST Rabe-System-Technik und Vertriebs-GmbH
Otto-Lilienthal-Strasse 19
49134 Wallenhorst

DEUTSCHLAND

+49 5407 8766-0
+49 5407 8766-99
info@rst.eu
www.rst.eu