

Artikelnummer RST Article Code RST	Herstellernummer Manufacturer Code	Gewinde Entry Thread	Klemmbereich Clamping Range (mm)		Klemmbereich innerer Dichteinsatz Clamping Range inner Sealing (mm)		 1/2	L (mm)	H max. (mm)	VPE * PU *
			≥	≤	≥	≤				
RAL9005	RAL9005									
84280525X4HI	EHIBMI-X5CDS	M25x1.5	13.0	18.0	10.0	13.0	33/33	10.0	41.6	25

Material	Polyamid 6	
Dichteinsatz	Chloropren	
Flachdichtung	Chloropren	
Einsatztemperatur	-40°C bis +70°C	
Entflammbarkeit (Polyamid 6)	UL-94 (HB)	
Entflammbarkeit (Chloropren)	UL-94 (HB)	
Schutzart gem. IEC 60529	IP66/IP68 (5bar/30Min.)	
ATEX-Kennzeichnung	Ex II 2 GD Ex e IIC Gb / Ex tb IIIC Db	
Zugentlastung gem. EN 60079-0 (Anhang A)	25 %	
Schlagresistenz	7 Joule	
Empfohlenes Anzugsdrehmoment	Hutmutter 7.5 Nm	Stutzen 2.5 Nm
CE-Kennzeichnung	ja (Richtlinie 2014/34/EU)	
Zolltarif-Nummer	39269097	
Gewicht	0.025 kg	
RoHS (2015/863/EU)	konform	
REACH/SVHC (Art. 33 1907/2006)	keine SVHC-Stoffe enthalten	
Konfliktminerale (Dodd-Frank Act)	keine Konfliktminerale enthalten	

Für besondere Bedingungen oder Einschränkungen siehe entsprechende Produktdokumentation.

Material	Polyamide 6	
Sealing	Chloroprene	
Flat sealing	Chloroprene	
Operating Temperature	-40°C to +70°C	
Flammability (Polyamide 6)	UL-94 (HB)	
Flammability (Chloroprene)	UL-94 (HB)	
Protection Class rel. IEC 60529	IP66/IP68 (5bar/30min.)	
ATEX Marking	Ex II 2 GD Ex e IIC Gb / Ex tb IIIC Db	
Strain relief rel. EN 60079-0 (Appendix A)	25 %	
Impact Resistance	7 Joule	
Recommended Tightening Torque	Cap 7.5 Nm	Body 2.5 Nm
CE Marking	yes (Directive 2014/34/EU)	
Customs Tariff Number	39269097	
Weight	0.025 kg	
RoHS (2015/863/EU)	compliant	
REACH/SVHC (Art. 33 1907/2006)	contain no SVHC substances	
Konfliktminerale (Dodd-Frank Act)	contain no conflict minerals	

For specific conditions or limitations please see relevant product documentation.

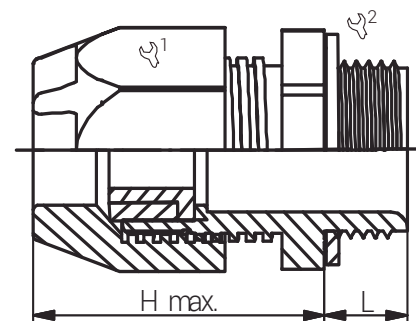
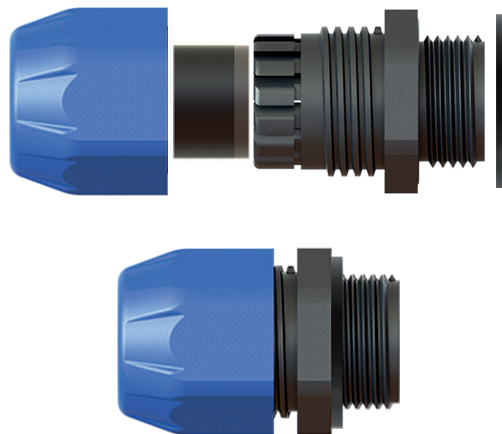

Kabelverschraubungen Ex Ex Cable Glands EURO-TOP X 4. Gen. DS M / Ex e (i)

Produktdokumentation Product Documentation



* Mindestbestellmenge (MOQ) kann größer sein als Verpackungseinheit (VPE).

* Minimum order quantity (MOQ) can be larger than packaging unit (PU).

RST Rabe-System-Technik und Vertriebs-GmbH
Otto-Lilienthal-Strasse 19
49134 Wallenhorst

DEUTSCHLAND

+49 5407 8766-0

+49 5407 8766-99

info@rst.eu

www.rst.eu