

Artikelnummer RST  
Article Code RST

Größe  
Size

D  
(mm)

H  
(mm)

C  
(mm)

VPE \*  
PU \*

01567034

M16

6.9

1.5

31.8

1

Material  
Zolltarif-Nummer  
Gewicht  
RoHS (2015/863/EU)  
REACH/SVHC (Art. 33 1907/2006)  
Konfliktminerale (Dodd-Frank Act)

Messing, vernickelt  
85369095  
0.007 kg  
konf. (Inanspruchnahme Ausnahme 6c)  
Blei enthalten  
keine Konfliktminerale enthalten

Material  
Customs Tariff Number  
Weight  
RoHS (2015/863/EU)  
REACH/SVHC (Art. 33 1907/2006)  
Konfliktminerale (Dodd-Frank Act)

Nickel Plated Brass  
85369095  
0.007 kg  
compliant (claim exception 6c)  
contain lead  
contain no conflict minerals



Zubehör  
Accessories  
ERDUNGSFAHNE / M  
EARTH TAG / M

Produktdokumentation  
Product Documentation

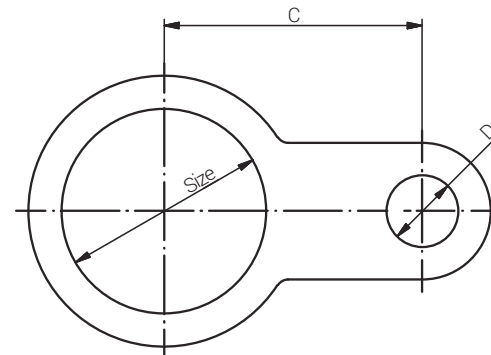

\* Mindestbestellmenge (MOQ) kann größer sein als Verpackungseinheit (VPE).  
\* Minimum order quantity (MOQ) can be larger than packaging unit (PU).

RST Rabe-System-Technik und Vertriebs-GmbH  
Otto-Lilienthal-Strasse 19  
49134 Wallenhorst

DEUTSCHLAND

+49 5407 8766-0  
+49 5407 8766-99  
info@rst.eu  
www.rst.eu