

Artikelnummer RST
Article Code RST

Größe
Size

D
(mm)

H
(mm)

L
(mm)

VPE *
PU *

01567054

M20

6.9

1.5

33.0

1

Material
Zolltarif-Nummer
Gewicht
RoHS (2015/863/EU)
REACH/SVHC (Art. 33 1907/2006)
Konfliktminerale (Dodd-Frank Act)

Messing, vernickelt
85369095
0.007 kg
konf. (Inanspruchnahme Ausnahme 6c)
Blei enthalten
keine Konfliktminerale enthalten

Material
Customs Tariff Number
Weight
RoHS (2015/863/EU)
REACH/SVHC (Art. 33 1907/2006)
Konfliktminerale (Dodd-Frank Act)

Nickel Plated Brass
85369095
0.007 kg
compliant (claim exception 6c)
contain lead
contain no conflict minerals



Zubehör
Accessories
ERDUNGSFAHNE / M
EARTH TAG / M

Produktdokumentation
Product Documentation

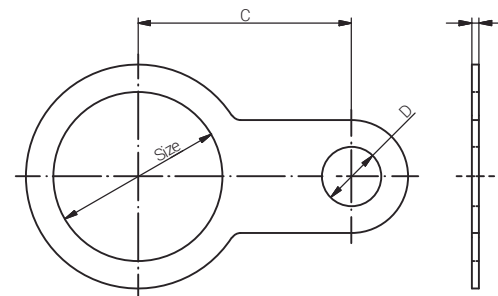

* Mindestbestellmenge (MOQ) kann größer sein als Verpackungseinheit (VPE).
* Minimum order quantity (MOQ) can be larger than packaging unit (PU).

RST Rabe-System-Technik und Vertriebs-GmbH
Otto-Lilienthal-Strasse 19
49134 Wallenhorst
DEUTSCHLAND

+49 5407 8766-0
+49 5407 8766-99
info@rst.eu
www.rst.eu