

Artikelnummer RST Article Code RST	Gewinde Entry Thread			Di (mm)	L (mm)	H (mm)	VPE* PU*
	AG / Male	IG / Female					
RAL7035	AG / Male	IG / Female					
11082532	M25x1.5	M32x1.5	36	19.0	10.0	18.0	50

Material	Polyamid 6 GF 30
Einsatztemperatur	-30°C bis +100°C
Entflammbarkeit (Polyamid 6 GF30)	UL-94 (HB)
Schutzart	Abhängig von der Kombination mit weiteren Komponenten.
Zolltarif-Nummer	39269097
Gewicht	0.010 kg
EAN-Nummer	4054838002824
RoHS (2015/863/EU)	konform
REACH/SVHC (Art. 33 1907/2006)	keine SVHC-Stoffe enthalten
Konfliktminerale (Dodd-Frank Act)	keine Konfliktminerale enthalten

Material	Polyamide 6 GF 30
Operating Temperature	-30°C to +100°C
Flammability (Polyamide 6 GF30)	UL-94 (HB)
Protection Class	Depending on the combination with further components.
Customs Tariff Number	39269097
Weight	0.010 kg
EAN Code	4054838002824
RoHS (2015/863/EU)	compliant
REACH/SVHC (Art. 33 1907/2006)	contain no SVHC substances
Konfliktminerale (Dodd-Frank Act)	contain no conflict minerals



Zubehör
Accessories
ERWEITERUNG SECHS-
KANT / M x M
ENLARGER HEXAGON
M x M

Produktdokumentation
Product Documentation

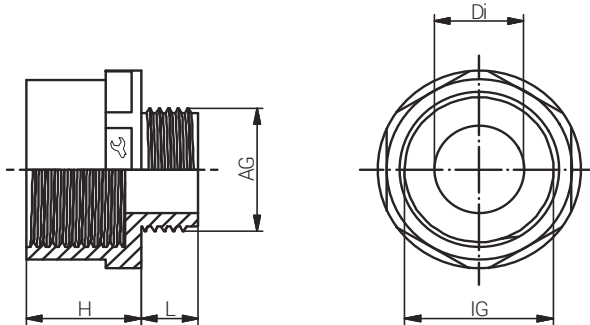

* Mindestbestellmenge (MOQ) kann größer sein als Verpackungseinheit (VPE).
* Minimum order quantity (MOQ) can be larger than packaging unit (PU).

RST Rabe-System-Technik und Vertriebs-GmbH
Otto-Lilienthal-Strasse 19
49134 Wallenhorst
DEUTSCHLAND

+49 5407 8766-0
+49 5407 8766-99
info@rst.eu
www.rst.eu