

Artikelnummer RST Article Code RST	Gewinde Entry Thread			Di (mm)	L (mm)	H (mm)	VPE* PU*
	AG / Male	IG / Female					
RAL7035	AG / Male	IG / Female					
11084248	PG 42	PG 48	65	45.5	13.0	28.0	10

Material	Polyamid
Einsatztemperatur	-30°C bis +100°C
Schutzart	Abhängig von der Kombination mit weiteren Komponenten.
Zolltarif-Nummer	39269097
Gewicht	0.037 kg
EAN-Nummer	4054838005641
RoHS (2015/863/EU)	konform
REACH/SVHC (Art. 33 1907/2006)	keine SVHC-Stoffe enthalten
Konfliktmineralien (Dodd-Frank Act)	keine Konfliktmineralien enthalten

Material	Polyamide
Operating Temperature	-30°C to +100°C
Protection Class	Depending on the combination with further components.
Customs Tariff Number	39269097
Weight	0.037 kg
EAN Code	4054838005641
RoHS (2015/863/EU)	compliant
REACH/SVHC (Art. 33 1907/2006)	contain no SVHC substances
Konfliktmineralien (Dodd-Frank Act)	contain no conflict minerals



Zubehör
Accessories
ERWEITERUNG SECHS-
KANT / PG x PG
ENLARGER HEXAGON
PG x PG

Produktdokumentation
Product Documentation

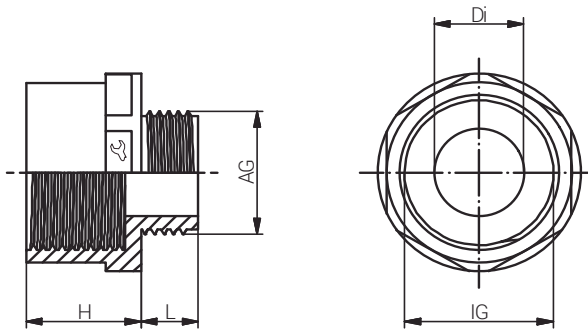
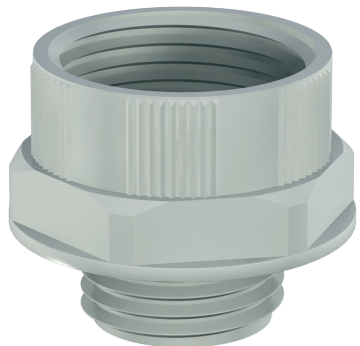

* Mindestbestellmenge (MOQ) kann größer sein als Verpackungseinheit (VPE).
* Minimum order quantity (MOQ) can be larger than packaging unit (PU).

RST Rabe-System-Technik und Vertriebs-GmbH
Otto-Lilienthal-Strasse 19
49134 Wallenhorst
DEUTSCHLAND

 +49 5407 8766-0
 +49 5407 8766-99
 info@rst.eu
 www.rst.eu