

Artikelnummer RST
Article Code RST

Gewinde
Entry Thread

D
(mm)

Di
(mm)

L
(mm)

H
(mm)

VPE*
PU*

AG / Male

IG / Female

62061621

PG 16

PG 21

30.0

18.5

6.5

14.5

50

Material
Schutzart
Zolltarif-Nummer
Gewicht
EAN-Nummer
RoHS (2015/863/EU)
REACH/SVHC (Art. 33 1907/2006)
Konfliktminerale (Dodd-Frank Act)

Messing, vernickelt
Abhängig von der Kombination mit weiteren Komponenten.
74198090
0.022 kg
4054838002749
konf. (Inanspruchnahme Ausnahme 6c)
Blei enthalten
keine Konfliktminerale enthalten

Material
Protection Class
Customs Tariff Number
Weight
EAN Code
RoHS (2015/863/EU)
REACH/SVHC (Art. 33 1907/2006)
Konfliktminerale (Dodd-Frank Act)

Nickel Plated Brass
Depending on the combination with further components.
74198090
0.022 kg
4054838002749
compliant (claim exception 6c)
contain lead
contain no conflict minerals



Zubehör

Accessories

ERWEITERUNG RUND

PG x PG

ENLARGER ROUND

PG x PG

Produktdokumentation

Product Documentation

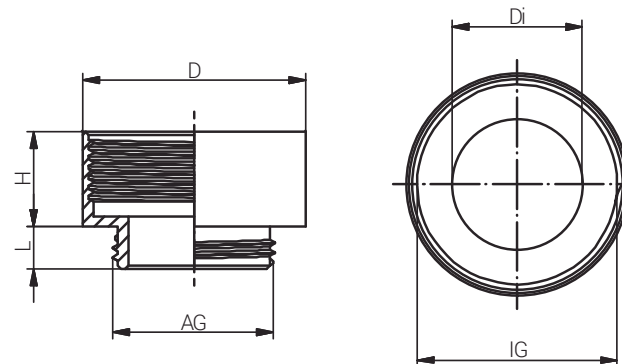

* Mindestbestellmenge (MOQ) kann größer sein als Verpackungseinheit (VPE).

* Minimum order quantity (MOQ) can be larger than packaging unit (PU).

RST Rabe-System-Technik und Vertriebs-GmbH
Otto-Lilienthal-Strasse 19
49134 Wallenhorst

DEUTSCHLAND

+49 5407 8766-0

+49 5407 8766-99

info@rst.eu

www.rst.eu