

Artikelnummer RST  
Article Code RST

Größe  
Size

D  
(mm)

D i  
(mm)

H  
(mm)

VPE \*  
PU \*

00221249

M12

18.0

11.0

1.2

20

Material Chloropren  
Einsatztemperatur -40°C bis +100°C  
Zolltarif-Nummer 40169300  
Gewicht 0.001 kg  
EAN-Nummer 3589352212493  
RoHS (2015/863/EU) konform  
REACH/SVHC (Art. 33 1907/2006) keine SVHC-Stoffe enthalten  
Konfliktminerale (Dodd-Frank Act) keine Konfliktminerale enthalten

Material Chloropren  
Operating Temperature -40°C to +100°C  
Customs Tariff Number 40169300  
Weight 0.001 kg  
EAN Code 3589352212493  
RoHS (2015/863/EU) compliant  
REACH/SVHC (Art. 33 1907/2006) contain no SVHC substances  
Konfliktminerale (Dodd-Frank Act) contain no conflict minerals



Zubehör  
Accessories  
FLACHDICHTUNG  
Chloropren / M  
FLAT SEALING WASHER  
Chloroprene / M

Produktdokumentation  
Product Documentation

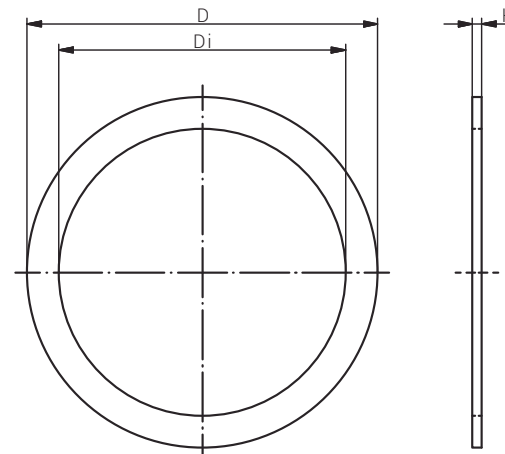
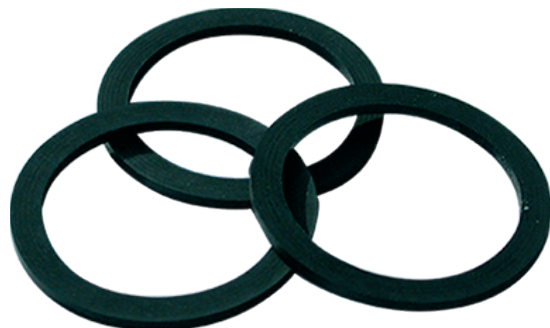

\* Mindestbestellmenge (MOQ) kann größer sein als Verpackungseinheit (VPE).

\* Minimum order quantity (MOQ) can be larger than packaging unit (PU).

RST Rabe-System-Technik und Vertriebs-GmbH  
Otto-Lilienthal-Strasse 19  
49134 Wallenhorst

DEUTSCHLAND

+49 5407 8766-0

+49 5407 8766-99

info@rst.eu

www.rst.eu