

Artikelnummer RST
Article Code RST

Größe
Size

D
(mm)

D i
(mm)

H
(mm)

VPE *
PU *

00224049

M40

52.0

38.5

1.5

20

Material Chloropren
Einsatztemperatur -40°C bis +100°C
Zolltarif-Nummer 40169300
Gewicht 0.002 kg
EAN-Nummer 3589352240496
RoHS (2015/863/EU) konform
REACH/SVHC (Art. 33 1907/2006) keine SVHC-Stoffe enthalten
Konfliktminerale (Dodd-Frank Act) keine Konfliktminerale enthalten

Material Chloropren
Operating Temperature -40°C to +100°C
Customs Tariff Number 40169300
Weight 0.002 kg
EAN Code 3589352240496
RoHS (2015/863/EU) compliant
REACH/SVHC (Art. 33 1907/2006) contain no SVHC substances
Konfliktminerale (Dodd-Frank Act) contain no conflict minerals



Zubehör
Accessories
FLACHDICHTUNG
Chloropren / M
FLAT SEALING WASHER
Chloroprene / M

Produktdokumentation
Product Documentation

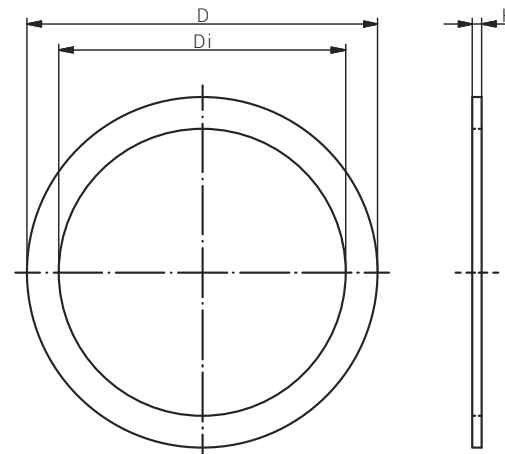
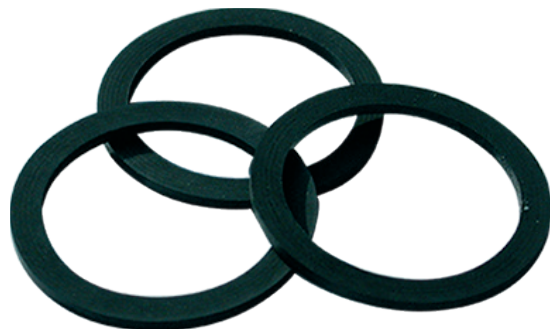

* Mindestbestellmenge (MOQ) kann größer sein als Verpackungseinheit (VPE).
* Minimum order quantity (MOQ) can be larger than packaging unit (PU).

RST Rabe-System-Technik und Vertriebs-GmbH
Otto-Lilienthal-Strasse 19
49134 Wallenhorst

DEUTSCHLAND

+49 5407 8766-0
+49 5407 8766-99
info@rst.eu
www.rst.eu