

Artikelnummer RST  
Article Code RST

Innengewinde  
Female Thread



H  
(mm)

VPE \*  
PU \*

61016525LF

M25x1.5

30

3.7

100

Material  
Zolltarif-Nummer  
Gewicht  
RoHS (2015/863/EU)  
REACH/SVHC (Art. 33 1907/2006)  
Konfliktminerale (Dodd-Frank Act)

Messing, vernickelt (bleifrei) CuZn42  
74153300  
0.011 kg  
konform  
keine SVHC-Stoffe enthalten  
keine Konfliktminerale enthalten

Material  
Customs Tariff Number  
Weight  
RoHS (2015/863/EU)  
REACH/SVHC (Art. 33 1907/2006)  
Konfliktminerale (Dodd-Frank Act)

Nickel Plated Brass (lead free) CuZn42  
74153300  
0.011 kg  
compliant  
contain no SVHC substances  
contain no conflict minerals



Zubehör  
Accessories  
GEGENMUTTER EMV  
LF / M  
LOCKNUT EMC  
LF / M



Produktdokumentation  
Product Documentation

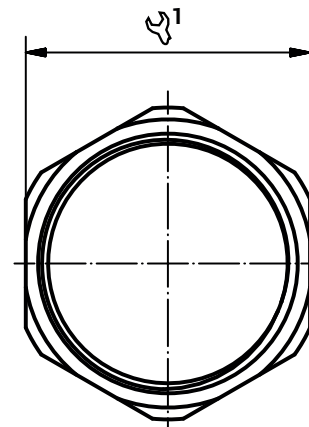

\* Mindestbestellmenge (MOQ) kann größer sein als Verpackungseinheit (VPE).  
\* Minimum order quantity (MOQ) can be larger than packaging unit (PU).

RST Rabe-System-Technik und Vertriebs-GmbH  
Otto-Lilienthal-Strasse 19  
49134 Wallenhorst

DEUTSCHLAND

+49 5407 8766-0  
+49 5407 8766-99  
info@rst.eu  
www.rst.eu