

Artikelnummer RST
Article Code RST

Innengewinde
Female Thread



H
(mm)

VPE *
PU *

61016563LF

M63x1.5

70

6.7

10

Material
Zolltarif-Nummer
Gewicht
RoHS (2015/863/EU)
REACH/SVHC (Art. 33 1907/2006)
Konfliktminerale (Dodd-Frank Act)

Messing, vernickelt (bleifrei) CuZn42
74153300
0.058 kg
konform
keine SVHC-Stoffe enthalten
keine Konfliktminerale enthalten

Material
Customs Tariff Number
Weight
RoHS (2015/863/EU)
REACH/SVHC (Art. 33 1907/2006)
Konfliktminerale (Dodd-Frank Act)

Nickel Plated Brass (lead free) CuZn42
74153300
0.058 kg
compliant
contain no SVHC substances
contain no conflict minerals



Zubehör
Accessories
GEGENMUTTER EMV
LF / M
LOCKNUT EMC
LF / M



Produktdokumentation
Product Documentation

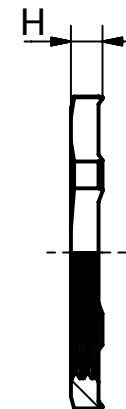
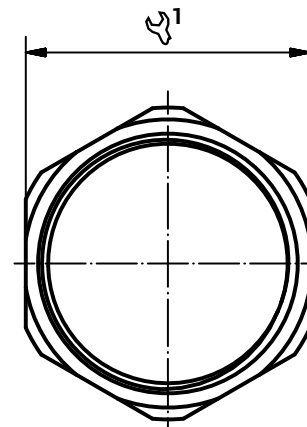

* Mindestbestellmenge (MOQ) kann größer sein als Verpackungseinheit (VPE).
* Minimum order quantity (MOQ) can be larger than packaging unit (PU).

RST Rabe-System-Technik und Vertriebs-GmbH
Otto-Lilienthal-Strasse 19
49134 Wallenhorst

DEUTSCHLAND

+49 5407 8766-0
+49 5407 8766-99
info@rst.eu
www.rst.eu