

Artikelnummer RST
Article Code RST

Innengewinde
Female Thread



H
(mm)

VPE *
PU *

61016436

PG 36

51

5.6

25

Material Messing, vernickelt
Zolltarif-Nummer 74153300
Gewicht 0.021 kg
EAN-Nummer 4054838007294
RoHS (2015/863/EU) konf. (Inanspruchnahme Ausnahme 6c)
REACH/SVHC (Art. 33 1907/2006) Blei enthalten
Konfliktminerale (Dodd-Frank Act) keine Konfliktminerale enthalten

Material Nickel Plated Brass
Customs Tariff Number 74153300
Weight 0.021 kg
EAN Code 4054838007294
RoHS (2015/863/EU) compliant (claim exception 6c)
REACH/SVHC (Art. 33 1907/2006) contain lead
Konfliktminerale (Dodd-Frank Act) contain no conflict minerals



Zubehör
Accessories
GEGENMUTTER EMV PG
LOCKNUT EMC PG

Produktdokumentation
Product Documentation

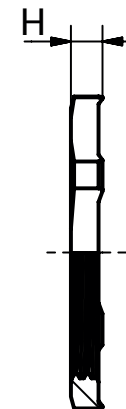
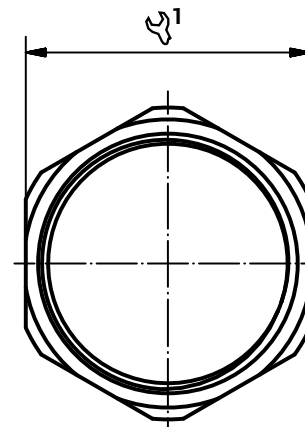

* Mindestbestellmenge (MOQ) kann größer sein als Verpackungseinheit (VPE).
* Minimum order quantity (MOQ) can be larger than packaging unit (PU).

RST Rabe-System-Technik und Vertriebs-GmbH
Otto-Lilienthal-Strasse 19
49134 Wallenhorst

DEUTSCHLAND

+49 5407 8766-0
+49 5407 8766-99
info@rst.eu
www.rst.eu