

Artikelnummer RST Article Code RST	Herstellernummer Manufacturer Code	Gewinde Entry Thread	Klemmbereich Clamping Range (mm)		 1/2	L (mm)	H (mm)	VPE PU
			≥	≤				
HU1610200051	1.610.2000.51	M20x1.5	5.0	9.0	22/22	6.0	23.0	50

Material	Messing, vernickelt	
Dichteinsatz	NBR	
Klemmeinsatz	Polyamid	
O-Ring	NBR	
Einsatztemperatur	-20°C bis +95°C	
Schutzart gem. IEC 60529	IP68(10bar)/IP69k	
Schutzart gem. UL50E	4X/6	
ATEX-Kennzeichnung	Ex 2G 1D / Ex e II / Ex tD A20	
Zugentlastung gem. EN 60079-0 (Anhang A)	25 %	
Empfohlenes Anzugsdrehmoment	Hutmutter	Stutzen
	8.0 Nm	8.0 Nm
CE-Kennzeichnung	ja (Richtlinie 2014/34/EU)	
Zolltarif-Nummer	74198090	
Gewicht	0.029 kg	
EAN-Nummer	4033878430538	
RoHS (2015/863/EU)	konf. (Inanspruchnahme Ausnahme 6c)	
REACH/SVHC (Art. 33 1907/2006)	Blei enthalten	
Konfliktminerale (Dodd-Frank Act)	keine Konfliktminerale enthalten	

Material	Nickel Plated Brass	
Sealing	NBR	
Clamping Insert	Polyamide	
O-Ring	NBR	
Operating Temperature	-20°C to +95°C	
Protection Class rel. IEC 60529	IP68(10bar)/IP69k	
Protection Class rel. UL50E	4X/6	
ATEX Marking	Ex 2G 1D / Ex e II / Ex tD A20	
Strain relief rel. EN 60079-0 (Appendix A)	25 %	
Recommended Tightening Torque	Cap	Body
	8.0 Nm	8.0 Nm
CE Marking	yes (Directive 2014/34/EU)	
Customs Tariff Number	74198090	
Weight	0.029 kg	
EAN Code	4033878430538	
RoHS (2015/863/EU)	compliant (claim exception 6c)	
REACH/SVHC (Art. 33 1907/2006)	contain lead	
Konfliktminerale (Dodd-Frank Act)	contain no conflict minerals	

Für besondere Bedingungen oder Einschränkungen siehe entsprechende Produktdokumentation.

For specific conditions or limitations please see relevant product documentation.

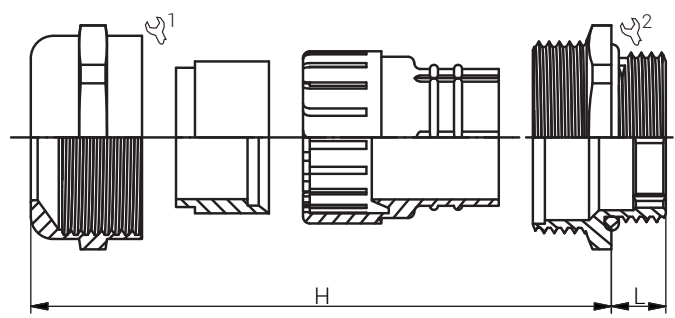

Kabelverschraubungen Ex Ex Cable Glands HSK-M-Ex / M

Produktdokumentation Product Documentation

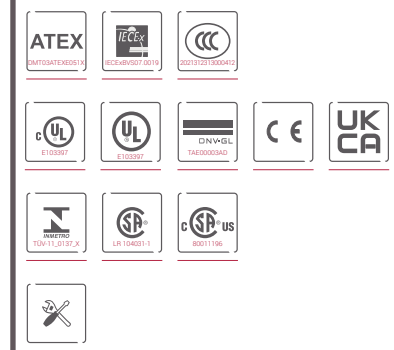

RST Rabe-System-Technik und Vertriebs-GmbH
 Otto-Lilienthal-Strasse 19
 49134 Wallenhorst
 DEUTSCHLAND
 ☎ +49 5407 8766-0
 📠 +49 5407 8766-99
 ✉ info@rst.eu
 🌐 www.rst.eu

Stand: 17.12.2024 Die hier genannten Angaben dienen lediglich der unverbindlichen Produktbeschreibung und erfolgen ohne Gewähr. Alle Informationen verstehen sich unter Vorbehalt und können inhaltliche bzw. druckbedingte Fehler enthalten. Weitere technische Angaben auf Anfrage.
 The information mentioned here is for product description purposes only and is given without guarantee. All information is subject to change and may contain errors in content or printing. Further technical information on request.