

Artikelnummer RST Article Code RST	Herstellernummer Manufacturer Code	Gewinde Entry Thread	Klemmbereich Clamping Range (mm)		 1/2	L (mm)	H (mm)	VPE PU
			≥	≤				
HU1610320050	1.610.3200.50	M32x1.5	20.0	25.0	40/40	8.0	31.0	25

Material	Messing, vernickelt	
Dichteinsatz	NBR	
Klemmeinsatz	Polyamid	
O-Ring	NBR	
Einsatztemperatur	-20°C bis +95°C	
Schutzart gem. IEC 60529	IP68(10bar)/IP69k	
Schutzart gem. UL50E	4X/6	
ATEX-Kennzeichnung	Ex 2G 1D / Ex e II / Ex tD A20	
Zugentlastung gem. EN 60079-0 (Anhang A)	25 %	
Empfohlenes Anzugsdrehmoment	Hutmutter	Stutzen
	15.0 Nm	15.0 Nm
CE-Kennzeichnung	ja (Richtlinie 2014/34/EU)	
Zolltarif-Nummer	74198090	
Gewicht	0.100 kg	
EAN-Nummer	4033878430729	
RoHS (2015/863/EU)	konf. (Inanspruchnahme Ausnahme 6c)	
REACH/SVHC (Art. 33 1907/2006)	Blei enthalten	
Konfliktminerale (Dodd-Frank Act)	keine Konfliktminerale enthalten	

Material	Nickel Plated Brass	
Sealing	NBR	
Clamping Insert	Polyamide	
O-Ring	NBR	
Operating Temperature	-20°C to +95°C	
Protection Class rel. IEC 60529	IP68(10bar)/IP69k	
Protection Class rel. UL50E	4X/6	
ATEX Marking	Ex 2G 1D / Ex e II / Ex tD A20	
Strain relief rel. EN 60079-0 (Appendix A)	25 %	
Recommended Tightening Torque	Cap	Body
	15.0 Nm	15.0 Nm
CE Marking	yes (Directive 2014/34/EU)	
Customs Tariff Number	74198090	
Weight	0.100 kg	
EAN Code	4033878430729	
RoHS (2015/863/EU)	compliant (claim exception 6c)	
REACH/SVHC (Art. 33 1907/2006)	contain lead	
Konfliktminerale (Dodd-Frank Act)	contain no conflict minerals	

Für besondere Bedingungen oder Einschränkungen siehe entsprechende Produktdokumentation.

For specific conditions or limitations please see relevant product documentation.

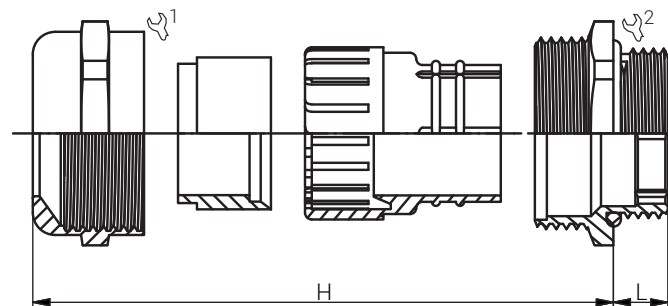

Kabelverschraubungen Ex Ex Cable Glands HSK-M-Ex / M

Produktdokumentation Product Documentation



RST Rabe-System-Technik und Vertriebs-GmbH
Otto-Lilienthal-Strasse 19
49134 Wallenhorst

DEUTSCHLAND

+49 5407 8766-0

+49 5407 8766-99

info@rst.eu

www.rst.eu