

Artikelnummer RST Article Code RST	Herstellernummer Manufacturer Code	Gewinde Entry Thread	Klemmbereich Clamping Range (mm)		 1/2	L (mm)	H max. (mm)	VPE * PU *
			≥	≤				
HU1699160050	1.699.1600.50	M16x1.5	4.0	8.0	17/19	6.0	21.0	50

Material	Messing, vernickelt
Dichteinsatz	FKM
Klemmeinsatz	PVDF
O-Ring	FKM
Einsatztemperatur	-35°C bis +150°C
Entflammbarkeit (PVDF)	UL-94 (V-0)
Schutzart gem. IEC 60529	IP68(10bar)/IP69k
Schutzart gem. UL50E	4X/6
Kat. der Schlägeinw. gem. EN 62444:2013	7 (10.0 Joule)
Empfohlenes Anzugsdrehmoment	Hutmutter 6.0 Nm Stutzen 6.0 Nm
CE-Kennzeichnung	ja (Richtlinie 2014/35/EU)
Zolltarif-Nummer	74198090
Gewicht	0.020 kg
EAN-Nummer	4033878443958
RoHS (2015/863/EU)	konf. (Inanspruchnahme Ausnahme 6c)
REACH/SVHC (Art. 33 1907/2006)	Blei enthalten
Konfliktminerale (Dodd-Frank Act)	keine Konfliktminerale enthalten

Material	Nickel Plated Brass
Sealing	FKM
Clamping Insert	PVDF
O-Ring	FKM
Operating Temperature	-35°C to +150°C
Flammability (PVDF)	UL-94 (V-0)
Protection Class rel. IEC 60529	IP68(10bar)/IP69k
Protection Class rel. UL50E	4X/6
Impact Category rel. EN 62444:2013	7 (10.0 Joule)
Recommended Tightening Torque	Cap 6.0 Nm Body 6.0 Nm
CE Marking	yes (Directive 2014/35/EU)
Customs Tariff Number	74198090
Weight	0.020 kg
EAN Code	4033878443958
RoHS (2015/863/EU)	compliant (claim exception 6c)
REACH/SVHC (Art. 33 1907/2006)	contain lead
Konfliktminerale (Dodd-Frank Act)	contain no conflict minerals

Für besondere Bedingungen oder Einschränkungen siehe entsprechende Produktdokumentation.

For specific conditions or limitations please see relevant product documentation.

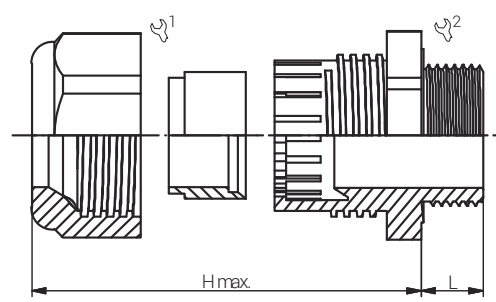
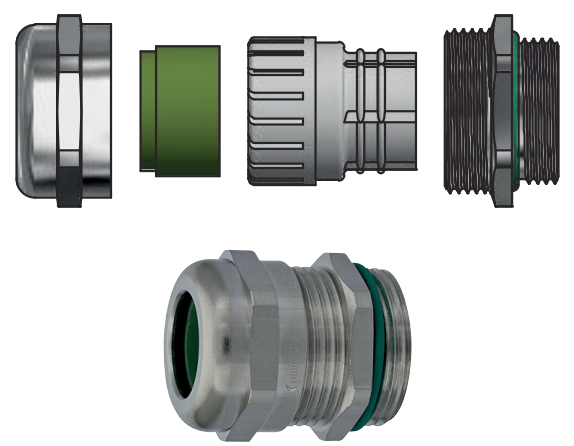

Kabelverschraubungen Standard Standard Cable Glands HSK-M-PVDF / M

Produktdokumentation Product Documentation



* Mindestbestellmenge (MOQ) kann größer sein als Verpackungseinheit (VPE).
* Minimum order quantity (MOQ) can be larger than packaging unit (PU).

RST Rabe-System-Technik und Vertriebs-GmbH
Otto-Lilienthal-Strasse 19
49134 Wallenhorst

DEUTSCHLAND

 +49 5407 8766-0
 +49 5407 8766-99
 info@rst.eu
 www.rst.eu