

Artikelnummer RST <i>Article Code RST</i>	Herstellernummer <i>Manufacturer Code</i>	N°	Klemmbereich <i>Clamping Range</i> (mm)		Für 	L (mm)	H (mm)	VPE * <i>PU *</i>
			≥	≤				
00810334	CAP810334	3	2.8	5.5	15	18.0	5.0	1

Material: Messing, vernickelt  
 Zolltarif-Nummer: 74198090  
 Gewicht: 0.006 kg  
 EAN-Nummer: 3589358103344  
 RoHS (2015/863/EU): konf. (Inanspruchnahme Ausnahme 6c)  
 REACH/SVHC (Art. 33 1907/2006): Blei enthalten  
 Konfliktminerale (Dodd-Frank Act): keine Konfliktminerale enthalten

*Material: Nickel Plated Brass*  
*Customs Tariff Number: 74198090*  
*Weight: 0.006 kg*  
*EAN Code: 3589358103344*  
*RoHS (2015/863/EU): compliant (claim exception 6c)*  
*REACH/SVHC (Art. 33 1907/2006): contain lead*  
*Konfliktminerale (Dodd-Frank Act): contain no conflict minerals*



Zubehör  
*Accessories*  
 KLEMMMODUL FÜR ADE  
*CLAMPING MODULE FOR ADE*

Produktdokumentation  
*Product Documentation*

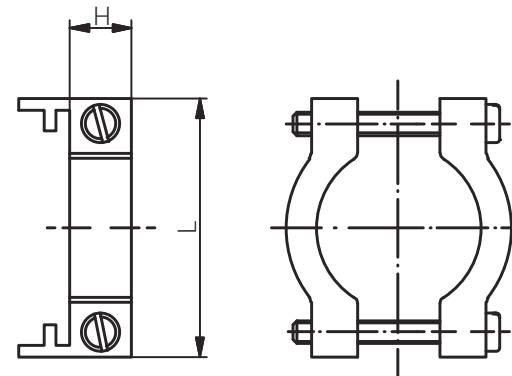
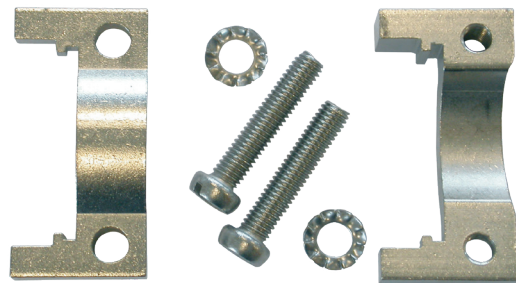

\* Mindestbestellmenge (MOQ) kann größer sein als Verpackungseinheit (VPE).  
 \* *Minimum order quantity (MOQ) can be larger than packaging unit (PU).*

**RST Rabe-System-Technik und Vertriebs-GmbH**  
 Otto-Lilienthal-Strasse 19  
 49134 Wallenhorst  
 DEUTSCHLAND

 +49 5407 8766-0  
 +49 5407 8766-99  
 [info@rst.eu](mailto:info@rst.eu)  
 [www.rst.eu](http://www.rst.eu)