

Artikelnummer RST <i>Article Code RST</i>	Herstellernummer <i>Manufacturer Code</i>	N°	Klemmbereich <i>Clamping Range</i> (mm)		Für 	L (mm)	H (mm)	VPE * <i>PU *</i>
			≥	≤				
00811034	CAP811034	10	27.0	41.0	55	59.0	9.5	1

Material: Messing, vernickelt
 Zolltarif-Nummer: 74198090
 Gewicht: 0.069 kg
 EAN-Nummer:
 RoHS (2015/863/EU): konf. (Inanspruchnahme Ausnahme 6c)
 REACH/SVHC (Art. 33 1907/2006): Blei enthalten
 Konfliktminerale (Dodd-Frank Act): keine Konfliktminerale enthalten

Material: Nickel Plated Brass
Customs Tariff Number: 74198090
Weight: 0.069 kg
EAN Code:
RoHS (2015/863/EU): compliant (claim exception 6c)
REACH/SVHC (Art. 33 1907/2006): contain lead
Konfliktminerale (Dodd-Frank Act): contain no conflict minerals



Zubehör
Accessories
 KLEMMMODUL FÜR ADE
CLAMPING MODULE FOR ADE

Produktdokumentation
Product Documentation

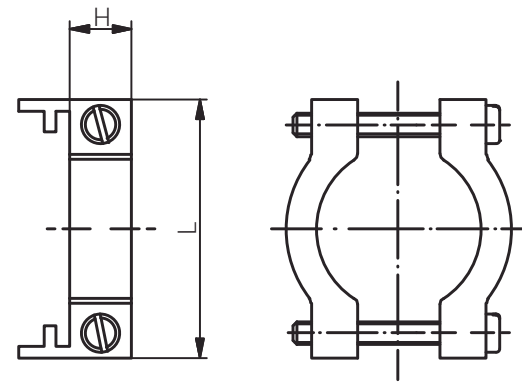
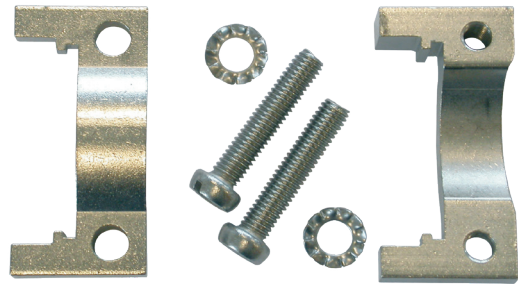

* Mindestbestellmenge (MOQ) kann größer sein als Verpackungseinheit (VPE).
 * *Minimum order quantity (MOQ) can be larger than packaging unit (PU).*

RST Rabe-System-Technik und Vertriebs-GmbH
 Otto-Lilienthal-Strasse 19
 49134 Wallenhorst
 DEUTSCHLAND

 +49 5407 8766-0
 +49 5407 8766-99
 info@rst.eu
 www.rst.eu