

Artikelnummer RST <i>Article Code RST</i>	Herstellernummer <i>Manufacturer Code</i>	Größe <i>Size</i>	Gewinde <i>Entry Thread</i>			Di <i>(mm)</i>	L <i>(mm)</i>	H <i>(mm)</i>	VPE * <i>PU *</i>
LPC20-M20-C-FG	LPC20-M20-C-FG	20	M20x1.5	34.0	30.0	14.5	12.0	34.0	1

Material	Edelstahl 316L
Einsatz	Messing, vernickelt
Dichtungen	Polyester-Elastomer
Dichtung zum Schlauch	Polyamid 6
Einsatztemperatur	-50°C bis +135°C
Schutzart gem. IEC 60529	IP66/IP68/IP69
CE-Kennzeichnung	ja (Richtlinie 2014/34/EU)
Zolltarif-Nummer	83079000
Gewicht	0.118 kg
RoHS (2015/863/EU)	konform (inanspruchnahme Ausnahme 6c)
REACH/SVHC (Art. 33 1907/2006)	Blei enthalten
Konfliktminerale (Dodd-Frank Act)	keine Konfliktminerale enthalten

<i>Material</i>	<i>Stainless Steel 316L</i>
<i>Insert</i>	<i>Nickel Plated Brass</i>
<i>Sealings</i>	<i>Polyester-Elastomer</i>
<i>Sealing to Conduit</i>	<i>Polyamide 6</i>
<i>Operating Temperature</i>	<i>-50°C to +135°C</i>
<i>Protection Class rel. IEC 60529</i>	<i>IP66/IP68/IP69</i>
<i>CE Marking</i>	<i>yes (Directive 2014/34/EU)</i>
<i>Customs Tariff Number</i>	<i>83079000</i>
<i>Weight</i>	<i>0.118 kg</i>
<i>RoHS (2015/863/EU)</i>	<i>compliant (claim exception 6c)</i>
<i>REACH/SVHC (Art. 33 1907/2006)</i>	<i>contain lead</i>
<i>Konfliktminerale (Dodd-Frank Act)</i>	<i>contain no conflict minerals</i>

Für besondere Bedingungen oder Einschränkungen siehe entsprechende Produktdokumentation.

For specific conditions or limitations please see relevant product documentation.

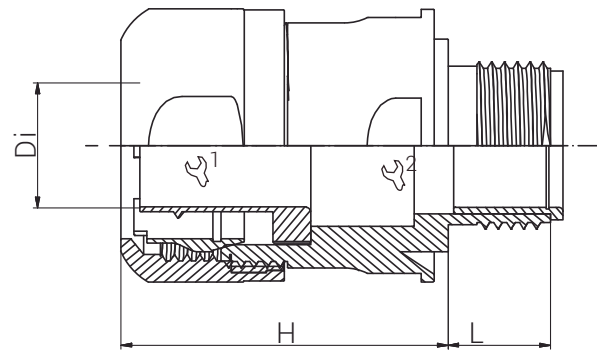
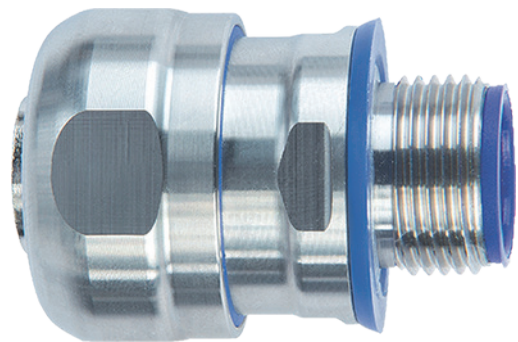

Schutzschlauchsysteme Conduit Systems LPC-FG / M

Produktdokumentation Product Documentation



* Mindestbestellmenge (MOQ) kann größer sein als Verpackungseinheit (VPE).
* Minimum order quantity (MOQ) can be larger than packaging unit (PU).

RST Rabe-System-Technik und Vertriebs-GmbH
Otto-Lilienthal-Strasse 19
49134 Wallenhorst
DEUTSCHLAND

 +49 5407 8766-0
 +49 5407 8766-99
 info@rst.eu
 www.rst.eu