

Artikelnummer RST Article Code RST	Herstellernummer Manufacturer Code	Größe Size	Gewinde Entry Thread			Di (mm)	L (mm)	H (mm)	VPE * PU *
LTP12-M16-C	LTP12-M16-C	12	M16x1.5	24.0	22.0	8.6	10.0	19.8	10

Material	Messing, vernickelt
Dichteinsatz	Polyamid
Einsatztemperatur	-50°C bis +135°C
Schutzart gem. IEC 60529	IP66/IP68/IP69
CE-Kennzeichnung	ja (Richtlinie 2014/35/EU)
Zolltarif-Nummer	83079000
Gewicht	0.035 kg
EAN-Nummer	
RoHS (2015/863/EU)	konf. (Inanspruchnahme Ausnahme 6c)
REACH/SVHC (Art. 33 1907/2006)	Blei enthalten
Konfliktminerale (Dodd-Frank Act)	keine Konfliktminerale enthalten

Material	Nickel Plated Brass
Sealing	Polyamide
Operating Temperature	-50°C to +135°C
Protection Class rel. IEC 60529	IP66/IP68/IP69
CE Marking	yes (Directive 2014/35/EU)
Customs Tariff Number	83079000
Weight	0.035 kg
EAN Code	
RoHS (2015/863/EU)	compliant (claim exception 6c)
REACH/SVHC (Art. 33 1907/2006)	contain lead
Konfliktminerale (Dodd-Frank Act)	contain no conflict minerals

Für besondere Bedingungen oder Einschränkungen siehe entsprechende Produktdokumentation.

For specific conditions or limitations please see relevant product documentation.

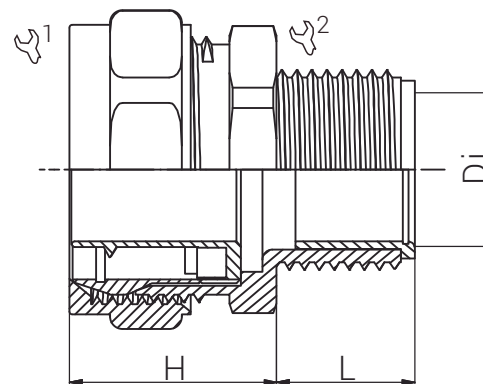
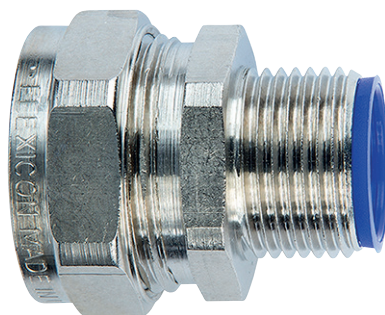

## Schutzschlauchsysteme Conduit Systems LTP-C / M



## Produktdokumentation Product Documentation

\* Mindestbestellmenge (MOQ) kann größer sein als Verpackungseinheit (VPE).

\* Minimum order quantity (MOQ) can be larger than packaging unit (PU).

**RST Rabe-System-Technik und Vertriebs-GmbH**  
Otto-Lilienthal-Strasse 19  
49134 Wallenhorst

DEUTSCHLAND

 +49 5407 8766-0

 +49 5407 8766-99

 [info@rst.eu](mailto:info@rst.eu)

 [www.rst.eu](http://www.rst.eu)