



Artikelnummer RST Article Code RST	Herstellernummer Manufacturer Code	Größe Size	Gewinde Entry Thread			Di (mm)	L (mm)	H (mm)	VPE * PU *
LTP25-M25-EXE	LTP25-M25-EXE	25	M25x1.5	35.0	33.0	18.0	14.0	26.7	10

Material	Messing, vernickelt
Dichteinsatz	Polyamid
Flachdichtung	Fiber
Einsatztemperatur	-20°C bis +85°C
Schutzart gem. IEC 60529	IP66
CE-Kennzeichnung	ja (Richtlinie 2014/35/EU)
Zolltarif-Nummer	83079000
Gewicht	
EAN-Nummer	
RoHS (2015/863/EU)	konf. (Inanspruchnahme Ausnahme 6c)
REACH/SVHC (Art. 33 1907/2006)	Blei enthalten
Konfliktminerale (Dodd-Frank Act)	keine Konfliktminerale enthalten

Material	Nickel Plated Brass
Sealing	Polyamide
Flat Sealing Washer	Fiber
Operating Temperature	-20°C to +85°C
Protection Class rel. IEC 60529	IP66
CE Marking	yes (Directive 2014/35/EU)
Customs Tariff Number	83079000
Weight	
EAN Code	
RoHS (2015/863/EU)	compliant (claim exception 6c)
REACH/SVHC (Art. 33 1907/2006)	contain lead
Konfliktminerale (Dodd-Frank Act)	contain no conflict minerals

Für besondere Bedingungen oder Einschränkungen siehe entsprechende Produktdokumentation.

For specific conditions or limitations please see relevant product documentation.

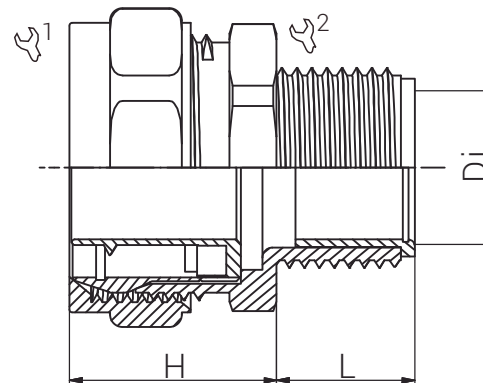
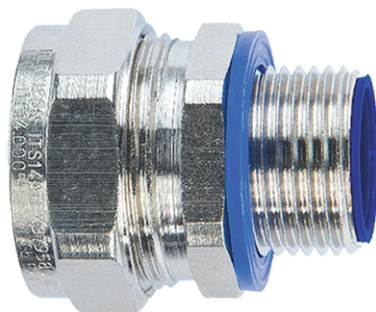

Schutzschlauchsysteme Conduit Systems LTP-EXE / M

Produktdokumentation Product Documentation



* Mindestbestellmenge (MOQ) kann größer sein als Verpackungseinheit (VPE).

* Minimum order quantity (MOQ) can be larger than packaging unit (PU).

RST Rabe-System-Technik und Vertriebs-GmbH
Otto-Lilienthal-Strasse 19
49134 Wallenhorst

DEUTSCHLAND

+49 5407 8766-0

+49 5407 8766-99

info@rst.eu

www.rst.eu