

Artikelnummer RST <i>Article Code RST</i>	Dichteinsatz-Bohrungen <i>Hole per Sealing</i> (mm)	Ersetzt Standard-Dichteinsatz mit dem Klemmbereich / <i>Replaced Standard Sealing</i> <i>with Clamping Range</i> (mm)		D (mm)	H (mm)	VPE * PU *
		≥	≤			
05616450	4x5.0	10.0	14.0	17.4	9.0	1

Material	TPE
Einsatztemperatur	-30°C bis +100°C
Zolltarif-Nummer	39269097
Gewicht	0.005 kg
RoHS (2015/863/EU)	konform
REACH/SVHC (Art. 33 1907/2006)	keine SVHC-Stoffe enthalten
Konfliktminerale (Dodd-Frank Act)	keine Konfliktminerale enthalten

<i>Material</i>	<i>TPE</i>
<i>Operating Temperature</i>	<i>-30°C to +100°C</i>
<i>Customs Tariff Number</i>	<i>39269097</i>
<i>Weight</i>	<i>0.005 kg</i>
<i>RoHS (2015/863/EU)</i>	<i>compliant</i>
<i>REACH/SVHC (Art. 33 1907/2006)</i>	<i>contain no SVHC substances</i>
<i>Konfliktminerale (Dodd-Frank Act)</i>	<i>contain no conflict minerals</i>



Zubehör
Accessories
 MEHRFACHDICHTEIN-
 SATZ FÜR EURO-TOP
 MULTIPLE SEALING IN-
 SERT FOR EURO-TOP

Produktdokumentation
Product Documentation

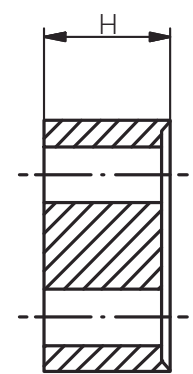
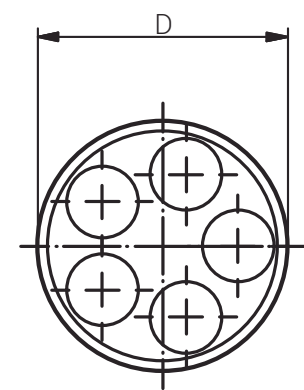

* Mindestbestellmenge (MOQ) kann größer sein als Verpackungseinheit (VPE).
 * *Minimum order quantity (MOQ) can be larger than packaging unit (PU).*

RST Rabe-System-Technik und Vertriebs-GmbH
 Otto-Lilienthal-Strasse 19
 49134 Wallenhorst

DEUTSCHLAND
 ☎ +49 5407 8766-0
 📠 +49 5407 8766-99
 ✉ info@rst.eu
 🌐 www.rst.eu