

Artikelnummer RST <i>Article Code RST</i>	Dichteinsatz-Bohrungen <i>Hole per Sealing</i> (mm)	Ersetzt Standard-Dichteinsatz mit dem Klemmbereich / <i>Replaced Standard Sealing</i> <i>with Clamping Range</i> (mm)		D (mm)	H (mm)	VPE * PU *
		≥	≤			
05625260	2x6.0	11.0	17.0	19.8	9.3	1

Material	TPE
Einsatztemperatur	-30°C bis +100°C
Zolltarif-Nummer	39269097
Gewicht	0.003 kg
RoHS (2015/863/EU)	konform
REACH/SVHC (Art. 33 1907/2006)	keine SVHC-Stoffe enthalten
Konfliktminerale (Dodd-Frank Act)	keine Konfliktminerale enthalten

<i>Material</i>	<i>TPE</i>
<i>Operating Temperature</i>	<i>-30°C to +100°C</i>
<i>Customs Tariff Number</i>	<i>39269097</i>
<i>Weight</i>	<i>0.003 kg</i>
<i>RoHS (2015/863/EU)</i>	<i>compliant</i>
<i>REACH/SVHC (Art. 33 1907/2006)</i>	<i>contain no SVHC substances</i>
<i>Konfliktminerale (Dodd-Frank Act)</i>	<i>contain no conflict minerals</i>



Zubehör  
*Accessories*  
 MEHRFACHDICHTEIN-  
 SATZ FÜR EURO-TOP  
 MULTIPLE SEALING IN-  
 SERT FOR EURO-TOP

Produktdokumentation  
*Product Documentation*

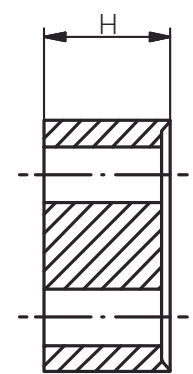
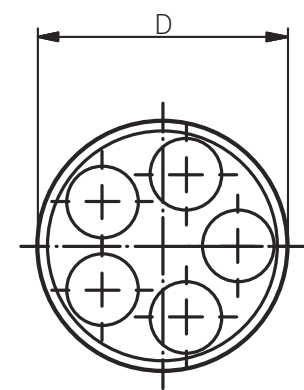

\* Mindestbestellmenge (MOQ) kann größer sein als Verpackungseinheit (VPE).  
 \* *Minimum order quantity (MOQ) can be larger than packaging unit (PU).*

**RST Rabe-System-Technik und Vertriebs-GmbH**  
 Otto-Lilienthal-Strasse 19  
 49134 Wallenhorst

DEUTSCHLAND  
 ☎ +49 5407 8766-0  
 📠 +49 5407 8766-99  
 ✉ info@rst.eu  
 🌐 www.rst.eu