

Artikelnummer RST Article Code RST	Gewinde Entry Thread			L (mm)	H (mm)	VPE * PU *
	AG / Male	IG / Female				
RAL7035	AG / Male	IG / Female				
11085025	M50x1.5	M25x1.5	55	14.0	7.0	5

Material	Polyamid 6 GF 30
Einsatztemperatur	-30°C bis +100°C
Entflammbarkeit (Polyamid 6 GF30)	UL-94 (HB)
Schutzart	Abhängig von der Kombination mit weiteren Komponenten.
Zolltarif-Nummer	39269097
Gewicht	0.022 kg
EAN-Nummer	4054838005801
RoHS (2015/863/EU)	konform
REACH/SVHC (Art. 33 1907/2006)	keine SVHC-Stoffe enthalten
Konfliktminerale (Dodd-Frank Act)	keine Konfliktminerale enthalten

Material	Polyamide 6 GF 30
Operating Temperature	-30°C to +100°C
Flammability (Polyamide 6 GF30)	UL-94 (HB)
Protection Class	Depending on the combination with further components.
Customs Tariff Number	39269097
Weight	0.022 kg
EAN Code	4054838005801
RoHS (2015/863/EU)	compliant
REACH/SVHC (Art. 33 1907/2006)	contain no SVHC substances
Konfliktminerale (Dodd-Frank Act)	contain no conflict minerals



Zubehör
Accessories
REDUZIERUNG SECHS-
KANT / M x M
REDUCER HEXAGON
M x M

Produktdokumentation
Product Documentation

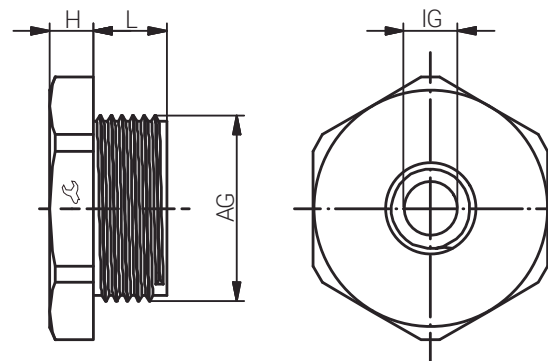
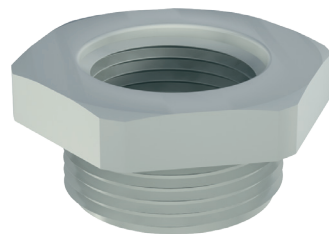

* Mindestbestellmenge (MOQ) kann größer sein als Verpackungseinheit (VPE).

* Minimum order quantity (MOQ) can be larger than packaging unit (PU).

RST Rabe-System-Technik und Vertriebs-GmbH
Otto-Lilienthal-Strasse 19
49134 Wallenhorst

DEUTSCHLAND

+49 5407 8766-0

+49 5407 8766-99

info@rst.eu

www.rst.eu