

Artikelnummer RST Article Code RST	Gewinde Entry Thread			L (mm)	H (mm)	VPE * PU *
	AG / Male	IG / Female				
RAL7035	AG / Male	IG / Female				
11082111	PG 21	PG 11	32	11.0	5.0	100

Material	Polyamid 6 GF
Einsatztemperatur	-30°C bis +100°C
Schutzart	Abhängig von der Kombination mit weiteren Komponenten.
Zolltarif-Nummer	39269097
Gewicht	0.009 kg
EAN-Nummer	4054838005962
RoHS (2015/863/EU)	konform
REACH/SVHC (Art. 33 1907/2006)	keine SVHC-Stoffe enthalten
Konfliktminerale (Dodd-Frank Act)	keine Konfliktminerale enthalten

Material	Polyamide 6 GF
Operating Temperature	-30°C to +100°C
Protection Class	Depending on the combination with further components.
Customs Tariff Number	39269097
Weight	0.009 kg
EAN Code	4054838005962
RoHS (2015/863/EU)	compliant
REACH/SVHC (Art. 33 1907/2006)	contain no SVHC substances
Konfliktminerale (Dodd-Frank Act)	contain no conflict minerals



Zubehör
Accessories
REDUZIERUNG SECHS-
KANT / PG x PG
REDUCER HEXAGON
PG x PG

Produktdokumentation
Product Documentation

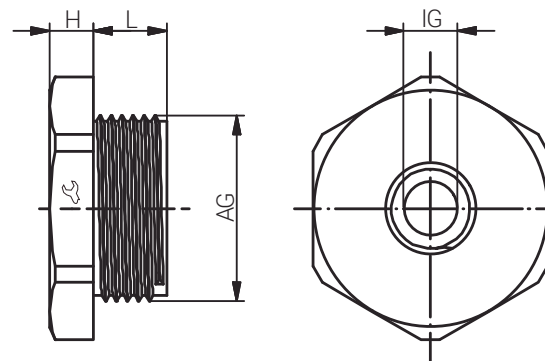
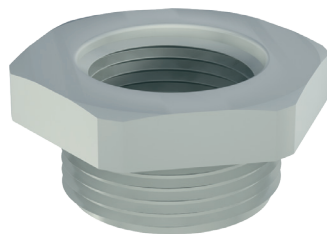

* Mindestbestellmenge (MOQ) kann größer sein als Verpackungseinheit (VPE).

* Minimum order quantity (MOQ) can be larger than packaging unit (PU).

RST Rabe-System-Technik und Vertriebs-GmbH
Otto-Lilienthal-Strasse 19
49134 Wallenhorst

DEUTSCHLAND

 +49 5407 8766-0

 +49 5407 8766-99

 info@rst.eu

 www.rst.eu