

Artikelnummer RST  
Article Code RST

Gewinde  
Entry Thread

D  
(mm)

L  
(mm)

H  
(mm)

VPE \*  
PU \*

AG / Male

IG / Female

62064229

PG 42

PG 29

57.0

10.0

4.0

10

Material  
Schutzart  
Zolltarif-Nummer  
Gewicht  
EAN-Nummer  
RoHS (2015/863/EU)  
REACH/SVHC (Art. 33 1907/2006)  
Konfliktminerale (Dodd-Frank Act)

Messing, vernickelt  
Abhängig von der Kombination mit weiteren Komponenten.  
74198090  
0.144 kg  
4054838006419  
konf. (Inanspruchnahme Ausnahme 6c)  
Blei enthalten  
keine Konfliktminerale enthalten

Material  
Protection Class  
Customs Tariff Number  
Weight  
EAN Code  
RoHS (2015/863/EU)  
REACH/SVHC (Art. 33 1907/2006)  
Konfliktminerale (Dodd-Frank Act)

Nickel Plated Brass  
Depending on the combination with further components.  
74198090  
0.144 kg  
4054838006419  
compliant (claim exception 6c)  
contain lead  
contain no conflict minerals



Zubehör  
Accessories  
REDUZIERUNG  
GERÄNDELT / PG x PG  
REDUCER KNURLED  
PG x PG

Produktdokumentation  
Product Documentation

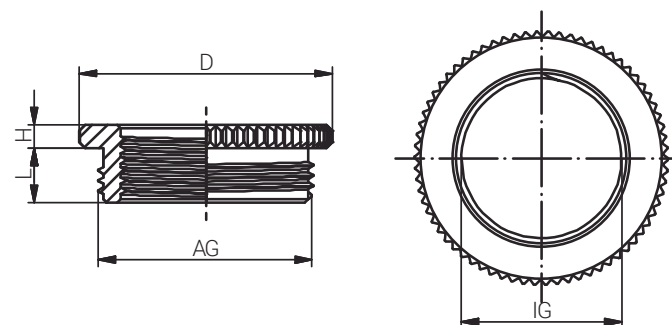
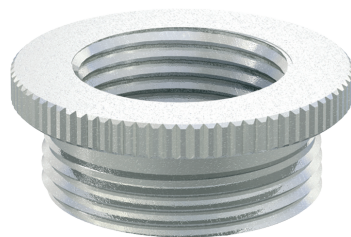

\* Mindestbestellmenge (MOQ) kann größer sein als Verpackungseinheit (VPE).  
\* Minimum order quantity (MOQ) can be larger than packaging unit (PU).

RST Rabe-System-Technik und Vertriebs-GmbH  
Otto-Lilienthal-Strasse 19  
49134 Wallenhorst

DEUTSCHLAND

+49 5407 8766-0  
+49 5407 8766-99  
info@rst.eu  
www.rst.eu