

Artikelnummer RST
Article Code RST

Größe
Size

D
(mm)

H
(mm)

VPE *
PU *

08004550

M50

45.0

0.50

1

Material Polyethylen
Einsatztemperatur -30°C bis +90°C
Zolltarif-Nummer 39269097
Gewicht 0.001 kg
RoHS (2015/863/EU) konform
REACH/SVHC (Art. 33 1907/2006) keine SVHC-Stoffe enthalten
Konfliktminerale (Dodd-Frank Act) keine Konfliktminerale enthalten

Material Polyethylene
Operating Temperature -30°C to +90°C
Customs Tariff Number 39269097
Weight 0.001 kg
RoHS (2015/863/EU) compliant
REACH/SVHC (Art. 33 1907/2006) contain no SVHC substances
Conflict minerals (Dodd-Frank Act) contain no conflict minerals



Zubehör
Accessories
STAUBSCHUTZSCHEIBE
Metrisch
DUST CAP / Metric

Produktdokumentation
Product Documentation

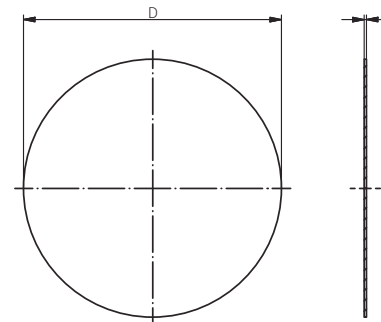

* Mindestbestellmenge (MOQ) kann größer sein als Verpackungseinheit (VPE).
* Minimum order quantity (MOQ) can be larger than packaging unit (PU).

RST Rabe-System-Technik und Vertriebs-GmbH
Otto-Lilienthal-Strasse 19
49134 Wallenhorst
DEUTSCHLAND

+49 5407 8766-0
+49 5407 8766-99
info@rst.eu
www.rst.eu