

Artikelnummer RST Article Code RST	Herstellernummer Manufacturer Code	Gewinde Entry Thread		L (mm)	H (mm)	VPE * PU *
RX190204	CYA1200YXN	M20x1.5	24	15.0	4.0	1

Material: Messing, vernickelt
 Schutzart gem. IEC 60529: IP66/IP68
 ATEX-Kennzeichnung: Ex II 2 G D / Ex d //C Gb / Ex e IIC Gb
 Ex tb IIIC Db
 Empfohlenes Anzugsdrehmoment: Stutzen siehe Montageanleitung
 CE-Kennzeichnung: ja (Richtlinie 2014/34/EU)
 Zolltarif-Nummer: 74198090
 Gewicht: 0.030 kg
 EAN-Nummer: 5056039096403
 RoHS (2015/863/EU): konf. (Inanspruchnahme Ausnahme 6c)
 REACH/SVHC (Art. 33 1907/2006): Blei enthalten
 Konfliktminerale (Dodd-Frank Act): keine Konfliktminerale enthalten

Material: Nickel Plated Brass
 Protection Class rel. IEC 60529: IP66/IP68
 ATEX Marking: Ex II 2 G D / Ex d //C Gb / Ex e IIC Gb
 Ex tb IIIC Db
 Recommended Tightening Torque: Body see assembly instruction
 CE Marking: yes (Directive 2014/34/EU)
 Customs Tariff Number: 74198090
 Weight: 0.030 kg
 EAN Code: 5056039096403
 RoHS (2015/863/EU): compliant (claim exception 6c)
 REACH/SVHC (Art. 33 1907/2006): contain lead
 Konfliktminerale (Dodd-Frank Act): contain no conflict minerals

Für besondere Bedingungen oder Einschränkungen siehe entsprechende Produktdokumentation.

For specific conditions or limitations please see relevant product documentation.

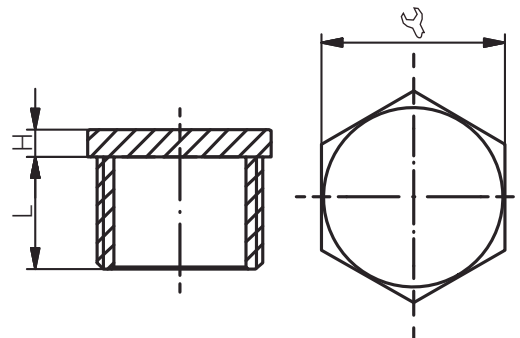

Zubehör
 Accessories
 VERSCHLUSSSCHRAUBE
 AUSSENSECHSKANT / M
 PLUG HEXAGON / M

Produktdokumentation
 Product Documentation



* Mindestbestellmenge (MOQ) kann größer sein als Verpackungseinheit (VPE).

* Minimum order quantity (MOQ) can be larger than packaging unit (PU).

RST Rabe-System-Technik und Vertriebs-GmbH
 Otto-Lilienthal-Strasse 19
 49134 Wallenhorst

DEUTSCHLAND

 +49 5407 8766-0
 +49 5407 8766-99
 info@rst.eu
 www.rst.eu