

Artikelnummer RST Article Code RST	Herstellernummer Manufacturer Code	Gewinde Entry Thread		L (mm)	H (mm)	VPE * PU *
CQA1200Y	CQA1200Y	M20x1.5	10	25.0	15.0	1

Material	Messing, blank
Schutzart gem. IEC 60529	IP68
ATEX-Kenzeichnung	Ex II 2 G D / Ex d IIC Gb / Ex e IIC Gb Ex tb IIIC Db
Empfohlenes Anzugsdrehmoment	Stutzen siehe Montageanleitung
CE-Kennzeichnung	ja (Richtlinie 2014/34/EU)
Zolltarif-Nummer	74198090
Gewicht	0.045 kg
EAN-Nummer	5056039096199
RoHS (2015/863/EU)	konf. (Inanspruchnahme Ausnahme 6c)
REACH/SVHC (Art. 33 1907/2006)	Blei enthalten
Konfliktminerale (Dodd-Frank Act)	keine Konfliktminerale enthalten

Material	Natural Brass
Protection Class rel. IEC 60529	IP68
ATEX Marking	Ex II 2 G D / Ex d IIC Gb / Ex e IIC Gb Ex tb IIIC Db
Recommended Tightening Torque	Body see assembly instruction
CE Marking	yes (Directive 2014/34/EU)
Customs Tariff Number	74198090
Weight	0.045 kg
EAN Code	5056039096199
RoHS (2015/863/EU)	compliant (claim exception 6c)
REACH/SVHC (Art. 33 1907/2006)	contain lead
Konfliktminerale (Dodd-Frank Act)	contain no conflict minerals

Für besondere Bedingungen oder Einschränkungen siehe entsprechende Produktdokumentation.

For specific conditions or limitations please see relevant product documentation.



Innensechskant /
Allen Key

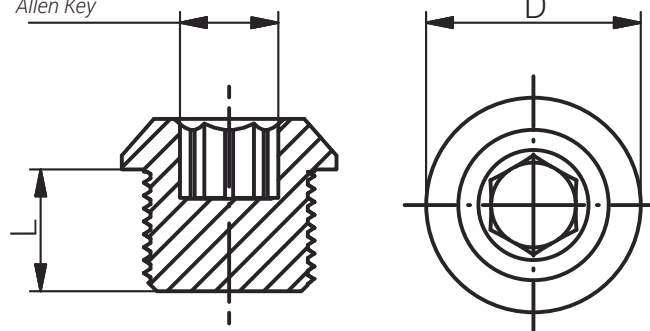

Zubehör
Accessories
VERSCHLUSSSCHRAUBE
INNENSECHSKANT / M
PLUG ALLEN SCREW / M

Produktdokumentation
Product Documentation



* Mindestbestellmenge (MOQ) kann größer sein als Verpackungseinheit (VPE).
* Minimum order quantity (MOQ) can be larger than packaging unit (PU).

RST Rabe-System-Technik und Vertriebs-GmbH
Otto-Lilienthal-Strasse 19
49134 Wallenhorst
DEUTSCHLAND

 +49 5407 8766-0
 +49 5407 8766-99
 info@rst.eu
 www.rst.eu