

Artikelnummer RST Article Code RST	Herstellernummer Manufacturer Code	Gewinde Entry Thread		L (mm)	H (mm)	VPE * PU *
CQE1300Y	CQE1300Y	M25x1.5	10	30.0	15.0	1

Material	Edelstahl 1.4404
Schutzart gem. IEC 60529	IP68
ATEX-Kenzeichnung	Ex II 2 G D / Ex d IIC Gb / Ex e IIC Gb Ex tb IIIC Db
Empfohlenes Anzugsdrehmoment	Stutzen siehe Montageanleitung
CE-Kennzeichnung	ja (Richtlinie 2014/34/EU)
Zolltarif-Nummer	73269098
Gewicht	0.075 kg
EAN-Nummer	5056039079864
RoHS (2015/863/EU)	konform
REACH/SVHC (Art. 33 1907/2006)	keine SVHC-Stoffe enthalten
Konfliktminerale (Dodd-Frank Act)	keine Konfliktminerale enthalten

Material	Stainless Steel
Protection Class rel. IEC 60529	IP68
ATEX Marking	Ex II 2 G D / Ex d IIC Gb / Ex e IIC Gb Ex tb IIIC Db
Recommended Tightening Torque	Body see assembly instruction
CE Marking	yes (Directive 2014/34/EU)
Customs Tariff Number	73269098
Weight	0.075 kg
EAN Code	5056039079864
RoHS (2015/863/EU)	compliant
REACH/SVHC (Art. 33 1907/2006)	contain no SVHC substances
Konfliktminerale (Dodd-Frank Act)	contain no conflict minerals

Für besondere Bedingungen oder Einschränkungen siehe entsprechende Produktdokumentation.

For specific conditions or limitations please see relevant product documentation.



Innensechskant /
Allen Key

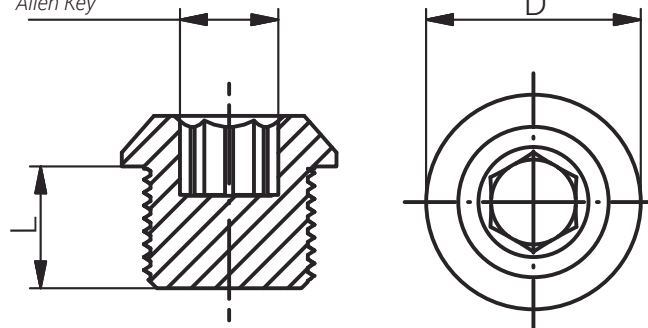

Zubehör Accessories VERSCHLUSSSCHRAUBE INNENSECHSKANT / M PLUG ALLEN SCREW / M

Produktdokumentation Product Documentation



* Mindestbestellmenge (MOQ) kann größer sein als Verpackungseinheit (VPE).

* Minimum order quantity (MOQ) can be larger than packaging unit (PU).

RST Rabe-System-Technik und Vertriebs-GmbH
Otto-Lilienthal-Strasse 19
49134 Wallenhorst

DEUTSCHLAND

+49 5407 8766-0

+49 5407 8766-99

info@rst.eu

www.rst.eu