

Artikelnummer RST Article Code RST	Herstellernummer Manufacturer Code	Gewinde Entry Thread		L min. (mm)	H (mm)	VPE * PU *
PDE400300	PDE400300	M16x1.5	10	24.00	15.0	1

Material	Polyamid 6
O-Ring	NRB
Einsatztemperatur	-20°C bis +40°C
Schutzart gem. IEC 60529	IP66/IP68
Schutzart gem. UL50E	4X
ATEX-Kennzeichnung	II2 GD / Ex e IIC Mb Gb / Ex tb IIIC Db
Schlagresistenz	4.0 Joule
Empfohlenes Anzugsdrehmoment	Stutzen siehe Montageanleitung
CE-Kennzeichnung	ja (Richtlinie 2014/34/EU)
Zolltarif-Nummer	39269097
Gewicht	0.018 kg
EAN-Nummer	5056009960260
RoHS (2015/863/EU)	konform
REACH/SVHC (Art. 33 1907/2006)	keine SVHC-Stoffe enthalten
Konfliktminerale (Dodd-Frank Act)	keine Konfliktminerale enthalten

Material	Polyamide 6
O-Ring	NRB
Operating Temperature	-20°C to +40°C
Protection Class rel. IEC 60529	IP66/IP68
Protection Class rel. UL50E	4X
ATEX Marking	II2 GD / Ex e IIC Mb Gb / Ex tb IIIC Db
Impact Resistance	4.0 Joule
Recommended Tightening Torque	Body see assembly instruction
CE Marking	yes (Directive 2014/34/EU)
Customs Tariff Number	39269097
Weight	0.018 kg
EAN Code	5056009960260
RoHS (2015/863/EU)	compliant
REACH/SVHC (Art. 33 1907/2006)	contain no SVHC substances
Konfliktminerale (Dodd-Frank Act)	contain no conflict minerals

Für besondere Bedingungen oder Einschränkungen siehe entsprechende Produktdokumentation.

For specific conditions or limitations please see relevant product documentation.

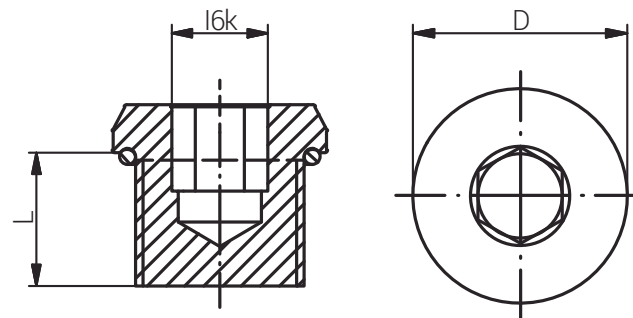

Zubehör Accessories VERSCHLUSSSCHRAU- BE INNENSECHSKANT / M PLUG ALLEN SCREW / M

Produktdokumentation Product Documentation



* Mindestbestellmenge (MOQ) kann größer sein als Verpackungseinheit (VPE).

* Minimum order quantity (MOQ) can be larger than packaging unit (PU).

RST Rabe-System-Technik und Vertriebs-GmbH
Otto-Lilienthal-Strasse 19
49134 Wallenhorst

DEUTSCHLAND

+49 5407 8766-0

+49 5407 8766-99

info@rst.eu

www.rst.eu