

Artikelnummer RST
Article Code RST

Gewinde
Entry Thread

D
(mm)

L
(mm)

H
(mm)

VPE *
PU *

99017520

M20x1.5

22.0

6.5

3.0

10

Material	Edelstahl 1.4305
O-Ring	NBR
Einsatztemperatur	-30°C bis+80°C
Schutzart	IP68
Zolltarif-Nummer	73269098
Gewicht	0.007 kg
EAN-Nummer	
RoHS (2015/863/EU)	konform
REACH/SVHC (Art. 33 1907/2006)	keine SVHC-Stoffe enthalten
Konfliktminerale (Dodd-Frank Act)	keine Konfliktminerale enthalten

Material	Stainless Steel 303
O-Ring	NBR
Operating Temperature	-30°C to+80°C
Protection Class	IP68
Customs Tariff Number	73269098
Weight	0.007 kg
EAN Code	
RoHS (2015/863/EU)	compliant
REACH/SVHC (Art. 33 1907/2006)	contain no SVHC substances
Konfliktminerale (Dodd-Frank Act)	contain no conflict minerals



Zubehör

Accessories

VERSCHLUSSCHRAUBE
RUND MIT O-RING / M
PLUG ROUND WITH
O-RING / M

Produktdokumentation
Product Documentation

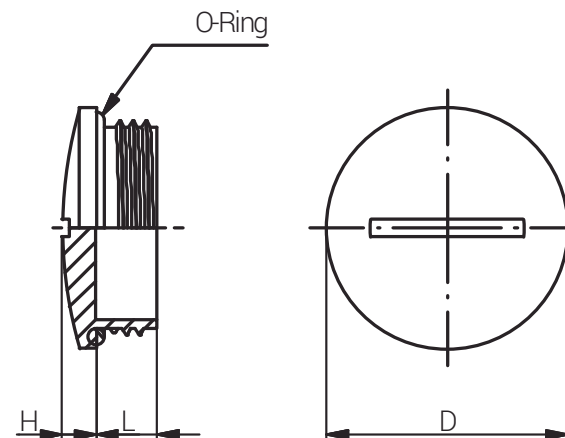

* Mindestbestellmenge (MOQ) kann größer sein als Verpackungseinheit (VPE).

* Minimum order quantity (MOQ) can be larger than packaging unit (PU).

RST Rabe-System-Technik und Vertriebs-GmbH
Otto-Lilienthal-Strasse 19
49134 Wallenhorst

DEUTSCHLAND

+49 5407 8766-0

+49 5407 8766-99

info@rst.eu

www.rst.eu